

# MP 200

## User manual

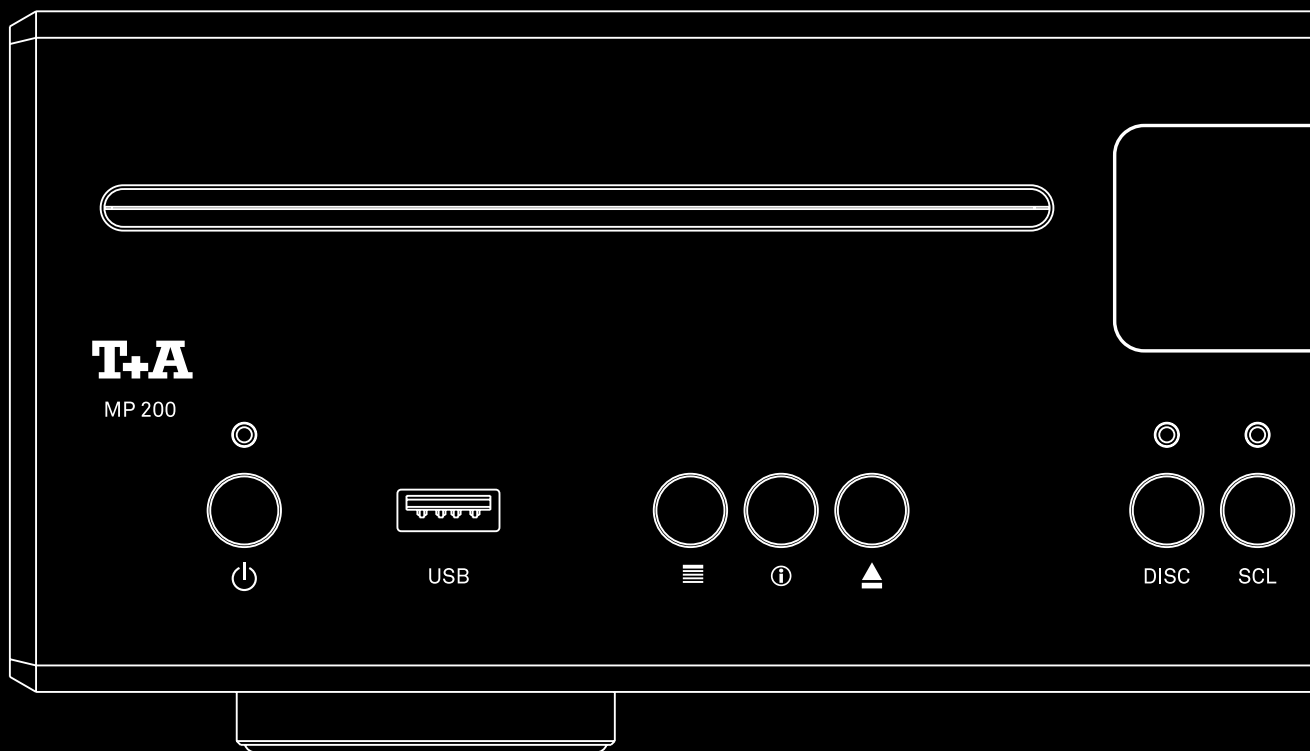



# Welcome

We are delighted that you have decided to purchase a T+A product. Your new Multi-Source-Player is a Hi-Fi unit of the highest quality, designed and developed with a single aim as top priority: to satisfy the requirements of the audiophile music lover.

This unit is the embodiment of innovative thinking and solid quality, exploiting the finest materials and components available, and all these factors contribute to a machine which will satisfy you're most stringent demands and your most searching requirements for a period of many years.

Our production areas are supervised by highly qualified expert staff, and all final production units are checked comprehensively by a fully automated, computer-controlled system to ensure uniformly high quality. We guarantee that our products meet our own specifications to the full.

At all stages of production we avoid the use of substances which are environmentally unsound or po-

tentially hazardous to health, such as chlorine-based cleaning agents and CFCs.

We also aim to avoid the use of plastics in general, and PVC in particular, in the design of our products. Instead we rely upon metals and other non-hazardous materials; metal components are ideal for recycling, and also provide effective electrical screening.

Our robust all-metal cases exclude any possibility of external sources of interference affecting the quality of reproduction. From the opposite point of view our products' electro-magnetic radiation (electro-smog) is reduced to an absolute minimum by the outstandingly effective screening provided by the metal case.

We would like to take this opportunity to thank you for the faith you have shown in our company by purchasing this product, and wish you many hours of enjoyment and sheer listening pleasure with your MP 200.

# Content

<b>Safety notes</b>	<b>10</b>
<b>Getting started</b>	<b>12</b>
General information	12
Scope of delivery	12
Set up	12
Connections	12
Wiring diagram	13
Switching on and off	14
Connecting to network	14
Selecting a source	15
Browsing through lists	15
Playback	16
<b>Connections</b>	<b>18</b>
Bluetooth antenna	18
Digital In- and Outputs (S/P-DIF)	18
LAN connection	18
USB input	18
System interfaces	19
Mains input	19
<b>Installation and connection</b>	<b>20</b>
Installation	20
Connection	20
WLAN antenna	20
LAN	20
BLUETOOTH antenna	21
Connection of digital source devices	21
Connected to a DAC 200 or HA 200	21
Operation with other devices	21
Connecting the power cord	21
<b>Controls and functions</b>	<b>22</b>
On / Off switch	22
Front USB socket	22
Function buttons	22
Source selection	23
System and source menu	23
Remote control receiver	23
Menu operation and playback control	23
Display	23
Disc drive	23

<b>Remote control</b>	<b>24</b>
On / Off Switch	24
Source selection	24
Settings	24
Playback and menu operation	24
Function buttons	25
Replacing the battery	26
Range	26
Important information	26
<b>Settings</b>	<b>27</b>
Menu operation	27
System settings	28
<b>Network configuration</b>	<b>31</b>
General information	31
Menu operation	31
Connection via LAN (cable connection)	31
Connecting to WLAN (radio connection)	32
<b>Source operation</b>	<b>34</b>
Selecting a source	34
Browsing through lists	35
Playback	35
Display	36
<b>Favourites list</b>	<b>38</b>
General information	38
Calling up the Favourites list	38
Adding a favourite	38
Erasing a favourite from the Favourites list	38
Play Favourites	39
Sort Favourites	39
<b>Radio operation</b>	<b>40</b>
General information	40
FM Radio	40
Display	40
Manual station search	41
Automatic station search	41
Mono / Stereo selection	41
Switching Radio Text on and off	41
DAB Radio	42
Display	42
Automatic station search	42
Internet Radio	43
Display	43
Search function	43
Favorites	43

<b>UPnP, Music services and USB</b>	<b>44</b>
General information	44
Source selection	44
Display	44
Playback of directories	44
<b>CD player operation</b>	<b>45</b>
Source selection	45
Insert and eject a disc	45
Playback mode	45
Playback Program	46
<b>Bluetooth</b>	<b>47</b>
General information	47
Source selection	47
Setting up audio transfer	47
Playback	47
<b>Playback with Roon</b>	<b>48</b>
General information	48
Playback	48
<b>T+A Music Navigator App</b>	<b>48</b>
Download	48
<b>Troubleshooting</b>	<b>49</b>
<b>Notes on energy saving</b>	<b>51</b>
General information	51
Automatic power down function	51
<b>Legal Information</b>	<b>51</b>
Allgemeine Informationen	51
Show licenses	51
<b>Firmware update</b>	<b>53</b>
General information	53
Update procedure	53
<b>Connection and wiring</b>	<b>54</b>
<b>Technical Specifications</b>	<b>56</b>



# Notes

## User manual

---



***Text passages marked with this symbol contain important information which must be observed if the machine is to operate safely and without problems.***

---



*This symbol marks text passages which provide supplementary notes and background information; they are intended to help the user understand how to get the best out of the machine.*

---

## Symbols and notes on the back of the MP 200

---



This symbol marks alternating voltages (AC).  
The AC voltage required for the device can be found on the printing at the mains input socket. Do not connect the device to other power supplies.

---



This symbol marks the protective earth connector (ground connection).  
The unit is designed for operation at a protective earth conductor socket.

---



The device is designed to operate in altitudes up to 2000 m above sea level.

---



The device is designed to operate in a temperate climate.  
The range of permissible operating temperatures is +10 ... +35°C.

---



The only permissible method of disposing of this product is to take it to your local collection centre for electrical waste.

---



All the components we use meet the German and European safety norms and standards which are currently valid. This product complies with the EU directives. The declaration of conformity can be downloaded from [www.ta-hifi.com/DoC](http://www.ta-hifi.com/DoC).

---



Attention! Please refer to the important safety information in this manual.

---



This product contains a class 1 laser diode. To ensure continued safety, do not remove any covers or attempt to gain access to the inside of the product.  
Refer all servicing to qualified personnel.

---



## License notice

---



Qualcomm is a trademark of Qualcomm Incorporated, registered in the United States and other countries, used with permission. aptX is a trademark of Qualcomm Technologies International, Ltd., registered in the United States and other countries, used with permission

---



The Bluetooth® word mark and logos are registered trademarks owned by Bluetooth SIG, Inc. and any use of such marks by T+A elektroakustik is under license. Other trademarks and trade names are those of their respective owners.

---



HD Radio Technology manufactured under license from iBiquity Digital Corporation. U.S. and Foreign Patents. HD Radio™ and the HD, HD Radio, and “Arc” logos are proprietary trademarks of iBiquity Digital Corp

---

This product contains software in form of object code that is partially based on free software under different licenses, especially the GNU General Public License. You can find details on this in the License Information which you should have received with this product.

If you have not received a copy of the GNU General Public License, please see <http://www.gnu.org/licenses/>.

For a period of three years after last distribution of this product or its firmware, T+A offer the right to any third party to obtain a complete machine-readable copy of the corresponding source code on physical storage medium (DVD-ROM or USB stick) for a charge of 20€. To obtain such copy of the source code, please write to the following address including information about product model and firmware version: T+A elektroakustik, Planckstr. 9-11, 32052 Herford, Germany.

The GPL license and further information about Licenses can be found on the internet under this link:

<http://www.ta-hifi.com/license-information>

It is also possible to retrieve the used licenses directly from the device with the help of an Internet browser. For details, see the chapter entitled „Legal Information“.

---



# Safety notes

For your own safety please consider it essential to read these operating instructions right through, and observe in particular the notes regarding setting up, operation and safety.

---

The operation instructions, the connection guidance and the safety notes are for your own good - please read them carefully and observe them at all times. The operating instructions are an integral part of this device. If you ever transfer the product to a new owner please be sure to pass them on to the purchaser to guard against incorrect operation and possible hazards.

---

The device is intended to be connected to a mains outlet with protective earth connector. Please connect it only with the mains cable supplied to properly installed mains outlets with protective earth connector. The power supply required for this unit is printed on the mains supply socket. The unit must never be connected to a power supply which does not meet these specifications.

---

This device is connected to the power supply as long as the power cord is connected. Even if the device is switched off and the status indicators are dark, the device still carries mains voltage inside. To disconnect the device completely from mains power supply, the mains plugs must be withdrawn from the wall socket. Please make sure that the mains plugs are easily accessible. Even when the unit is in standby mode, it has a low power consumption. If the unit is not to be used for a long period disconnect it from the mains supply at the wall socket.



The device is designed to operate in a temperate climate and altitudes up to 2000 m above sea level. The range of permissible operating temperatures is +10 ... +35°C.



This device is designed exclusively for reproducing sound and/or pictures in the domestic environment. It is to be used in a dry indoor room which meets all the recommendations stated in these instructions.

Where the equipment is to be used for other purposes, especially in the medical field or any field in which safety is an issue, it is essential to establish the unit's suitability for this purpose with the manufacturer, and to obtain prior written approval for this usage.

---

If the unit gets very cold (e. g. when being transported), condensation may form inside it. Please do not switch it on until it has had plenty of time to warm up to room temperature, so that any condensation evaporates completely.

---

Before placing the unit on sensitive lacquer or wood surfaces please check the compatibility of the surface and the unit's feet on a non-visible point and if necessary use an underlay. We recommend a surface of stone, glass, metal or the like.

---

Please consider the weight of the device. Never place the device on an unstable surface; the machine could fall off, causing serious or even fatal injury. Many injuries, especially to children, can be avoided if the following simple safety precautions are observed:

- Use only such items of furniture which can safely bear the weight of the device.
- Ensure that the device does not project beyond the edges of the supporting furniture.
- Do not place the device on tall furniture (e.g. bookshelves) without securely anchoring both items, i.e. furniture and device.
- Explain to children the hazards involved in climbing on furniture to reach the device or its controls.

---

The unit should be set up in a well ventilated dry site, out of direct sunlight and away from radiators. The unit must not be located close to heat producing objects or devices, or anything which is heat sensitive or highly flammable.

---

The ventilation openings must not be covered or closed. If the system components are to be stacked then the device must be the top unit. Do not place any object on the top cover. The device is not designed to be operated on a soft surface (such as bedding, pillows, etc.).

---

When installing the unit on a shelf or in a cupboard it is essential to provide an adequate flow of cooling air, to ensure that the heat produced by the unit is dissipated effectively. Any heat build up will shorten the life of the unit and could be a source of danger. Be sure to leave free space of 10 cm around the unit for ventilation.

---

Liquid or particles must never be allowed to get inside the unit through the ventilation slots. Mains voltage is present inside the unit, and any electric shock could cause serious injury or death. Never exert undue force on mains connectors.

Protect the unit from drips and splashes of water; never place flower vases or fluid containers on the unit. Do not place naked flame sources, such as candle lights on the device.

---

---

Disconnect the mains plug at the wall socket before cleaning the case.

The surfaces of the case should be wiped clean with a soft, dry cloth only.

Never use solvent-based or abrasive cleaners!

Before switching the unit on again, check that there are no short-circuits at the connections, and that all cables are plugged in correctly.

---

If the device has been in storage, or has not been used for a protracted period (> two years), it is essential to have it checked by a specialist technician before re-use.

---



The terminals (marked with the ⚠-symbol) can carry high voltages.

Always avoid touching terminals and sockets and the conductors of cables connected to them. Unless ready-made cables are used, all cables connected to these terminals and sockets must always be deployed by a trained person.

---



In its original condition the unit meets all currently valid European regulations. It is approved for use as stipulated within the EC.

By attaching the CE symbol to the unit T+A declares its conformity the EC directives and the national laws based on those directives. The declaration of conformity can be downloaded from [www.ta-hifi.com/DoC](http://www.ta-hifi.com/DoC). The original, unaltered factory serial number must be present on the outside of the unit and must be clearly legible! The serial number is a constituent part of our conformity declaration and therefore of the approval for operation of the device. The serial numbers on the unit and in the original T+A documentation supplied with it (in particular the inspection and guarantee certificates), must not be removed or modified, and must correspond.

Infringing any of these conditions invalidates T+A conformity and approval, and the unit may not be operated within the EC. Improper use of the equipment makes the user liable to penalty under current EC and national laws.

Any modifications or repairs to the unit, or any other intervention by a workshop or other third party not authorised by T+A, invalidates the approval and operational permit for the equipment.

Only genuine T+A accessories may be connected to the unit, or such auxiliary devices which are themselves approved and fulfil all currently valid legal requirements.

---



The only permissible method of disposing of this product is to take it to your local collection centre for electrical waste.

Registration according to the EU directive  
"Waste Electrical and Electronic Equipment"  
WEEE-Reg.-No.: DE **72473830W**

---

The case should only be opened by a qualified specialist technician. Repairs and fuse replacements should be entrusted to an authorised T+A specialist workshop. With the exception of the connections and measures described in these instructions, no work of any kind may be carried out on the device by unqualified persons.

If the unit is damaged, or if you suspect that it is not functioning correctly, immediately disconnect the mains plug at the wall socket, and ask an authorised T+A specialist workshop to check it.

---

The unit may be damaged by excess voltage in the power supply, the mains circuit or in aerial systems, as may occur during thunderstorms (lightning strikes) or due to static discharges.

Special power supply units and excess voltage protectors such as the T+A 'Power Bar' mains distribution panel offer some degree of protection from damage to equipment due to the hazards described above.

However, if you require absolute security from damage due to excess voltage, the only solution is to disconnect the unit from the mains power supply and any aerial systems.

To avoid the risk of damage by overvoltages we recommend to disconnect all cables from this device and your HiFi system during thunderstorms.

All mains power supply and aerial systems to which the unit is connected must meet all applicable safety regulations and must be installed by an approved electrical installer.

---

The device is not designed for use by children. The device must not be operated unsupervised. Make sure that it is out of reach of children.

---

Batteries should not be exposed to excessive heat like sunshine, fire or the like.

---

Very loud continuous listening to program material via earphones, headphones and loudspeakers can lead to permanent loss of hearing. Prevent health risks and avoid permanent hearing at high volume.

---

If the device has to be stored, place it in its original packaging and store it in a dry, frost-free location. Storage temperature range 0...40 °C

---

# Getting started

## General information

---

For a quick start into the listening pleasure of your new multi-source player, this chapter describes the most important steps for the first start-up and basic operation.

A detailed explanation of the operation and all functions can be found in the following chapters.

## Scope of delivery

---

Infrared remote control handset FM200

Power cord

2 antennas for WLAN and Bluetooth

2 antenna bases for the WLAN and Bluetooth antenna

Radio antenna with adapter

USB interface cable for USB-SYS connection (MP 200 to HA 200 or DAC 200)

System interface cable (RJ-45) for the SYS-OUT to SYS-IN connection (MP 200 to HA 200 or DAC 200)

## Set up

---

Set up the device at a appropriate place. Please observe all notes regarding connection and installation in the chapter *Safety notes* (pages 10 and 11).

## Connections

---

Establish all connections shown in the connection diagram. If you are operating the MP 200 via the LAN connection, you do not need to connect the WLAN antenna.

When using the WLAN connection, the two antennas should be positioned as far away from each other as possible.

Plug all connectors firmly into the corresponding sockets and screw the antenna connectors hand-tight.

The supplied radio antenna (cable antenna incl. adapter) must be unfolded completely and spread out in a T-shape for proper radio reception.



*The connection diagram (on the right side) shows the connection of the MP 200 in conjunction with a DAC 200. The HA 200 is connected in the same way.*

---

*Please refer to the wiring diagram in the chapter Connection and wiring for connecting the MP 200 to other devices.*

## Wiring diagram

For the first use, please establish the necessary connections as shown below.

- WLAN-antenna or network cable to your router
- VHF antenna
- Bluetooth antenna
- USB SYS conection (For operation in combination with a DAC 200 or HA 200)
- SYS OUT to SYS IN connection (For operation in combination with a DAC 200 or HA 200)
- Mains cord



**Do not connect the MP 200 and the other components to the power supply until all the necessary connections between the devices have been made.**

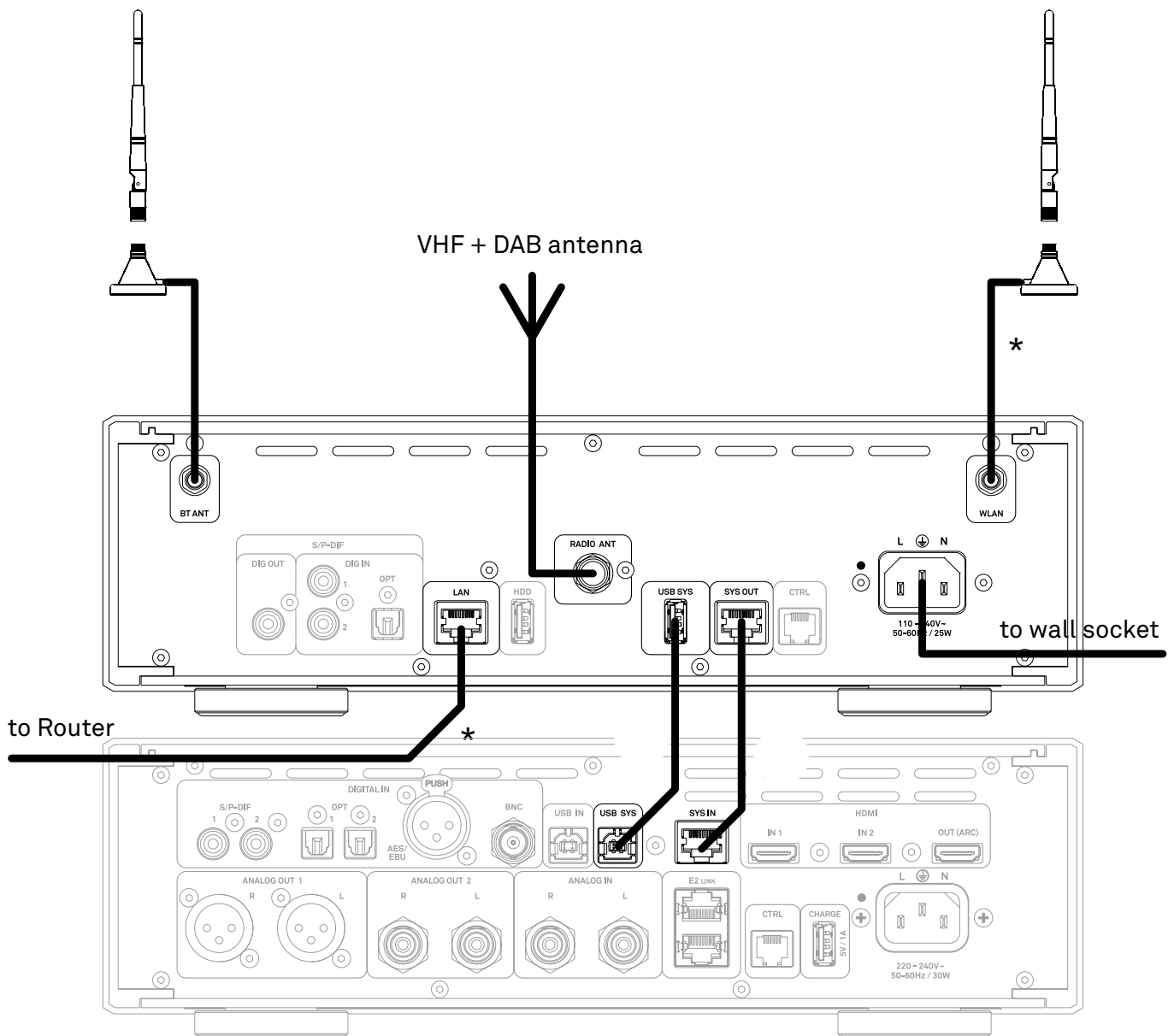
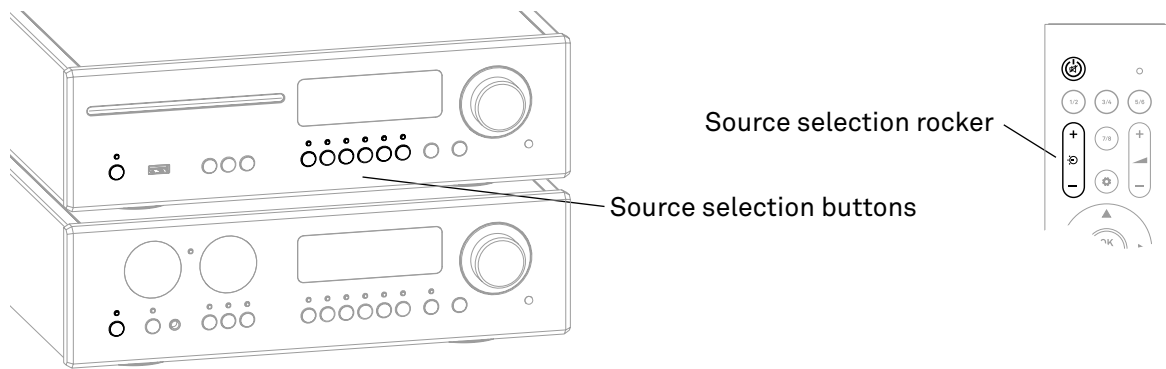





Fig. 1

\* Depending on which type of network connection you wish to use, connect the WLAN antenna or a network cable to the router.

## Switching on and off

---



- In stand-alone operation and in conjunction with a DAC 200 or HA 200, the MP 200 can be switched on and off by briefly tapping the  button on the MP 200.
- When operating in conjunction with a DAC 200 or HA 200, the devices can be switched off together using the  button on the DAC or HA.
- To switch on, either tap the  button on the device or the  button on the remote control.
- It is also possible to switch on the MP 200 directly with a source selection button on the device or the source selection rocker on the remote control.

### Example:

If you tap the source selection button DISC on the MP 200, it switches on with the source Disc. A possibly connected DAC 200 or HA 200 is automatically switched on and set to the system input SYS IN for playback.

## Connecting to network

---

### Wired network connection

If the MP 200 will be operated via a LAN connection and not via WLAN, connect the LAN port to an operational network (router) with Internet access as shown in Fig. 1.

After switching on and booting the streaming module, the device will automatically connect to your network.

-  *We recommend a wired network connection via LAN cable for streaming high-resolution music material. Depending on the reception quality and the traffic load from other users, a WLAN connection can reach its capacity limit more quickly, which may lead to playback dropouts.*

### Set up a WLAN connection automatically via WPS

- Make sure that the WLAN antenna is connected correctly. (Fig. 1)
- Start the WPS function of your router / access point (refer to the router's manual for information).
- Now open the system settings by a brief press on the SYS button on the front panel of the MP 200.
- Select the Network menu item by turning the SELECT knob and confirm by pressing the SELECT knob.
- Then select the *WPS Autoconnect* menu item by turning the SELECT knob.
- Start the WPS function of the MP 200 by pressing the SELECT knob.
- Wait until the device has automatically connected to the WLAN and the name of the network has been adopted in to the field *Status*.
- Exit the menu by a briefly pressing the SYS button again.

-  *If you prefer manual setup or setup via access point and our T+A Music Navigator App, you will find more information regarding WLAN setup in the chapter **Network configuration** starting on page 31.*

## Selecting a source

---

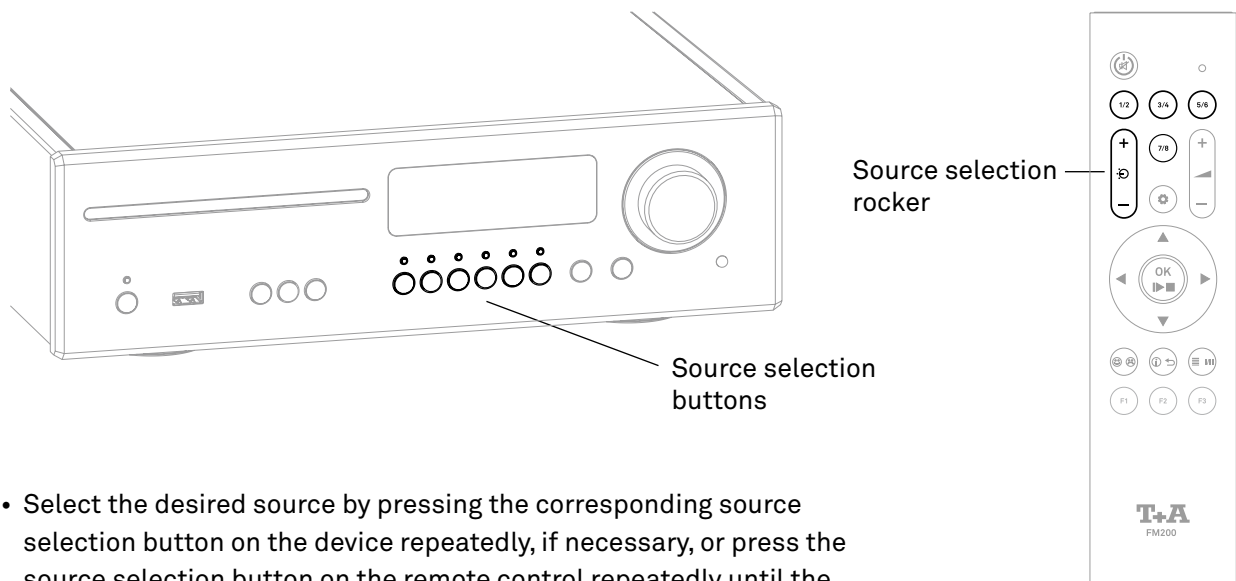

- Select the desired source by pressing the corresponding source selection button on the device repeatedly, if necessary, or press the source selection button on the remote control repeatedly until the source is shown in the display.
- When operating the MP 200 without a DAC 200 or HA 200, the source can alternatively be selected via the  $\text{\textcircled{1/2}}$  ...  $\text{\textcircled{7/8}}$  buttons on the remote control (press repeatedly if necessary).

---

**i** If the MP 200 is operated in a system network with a DAC 200 or an HA 200, the source selection buttons  $\text{\textcircled{1/2}}$  ...  $\text{\textcircled{7/8}}$  of the remote control are used for the source selection of the DAC 200 or HA 200 sources. In this case, source selection at the MP 200 via remote control is done exclusively via source selection rocker.

---

For a faster and more convenient source selection, not required sources can be deactivated in the system settings. See chapter **System settings**.

---

## Browsing through lists

---

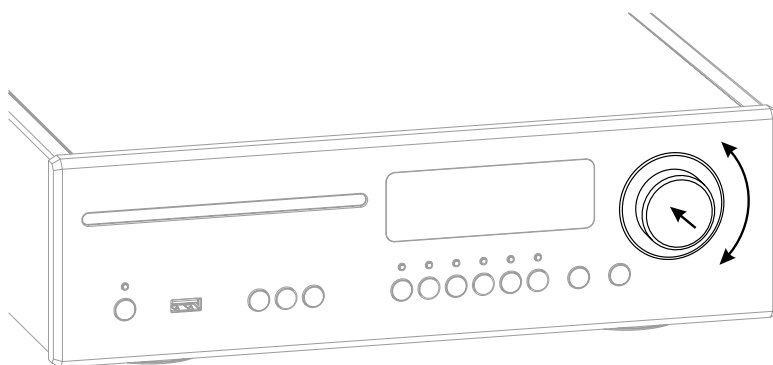

- A folder/title/station/favorite can be selected by turning the SELECT knob on the front panel. The selected list entry is displayed in enlarged form.
- The selected list entry can be opened or played by pressing the SELECT knob depending on the type (folder/title/station etc.).
- A long press on the SELECT knob jumps back to the previous level (if available).

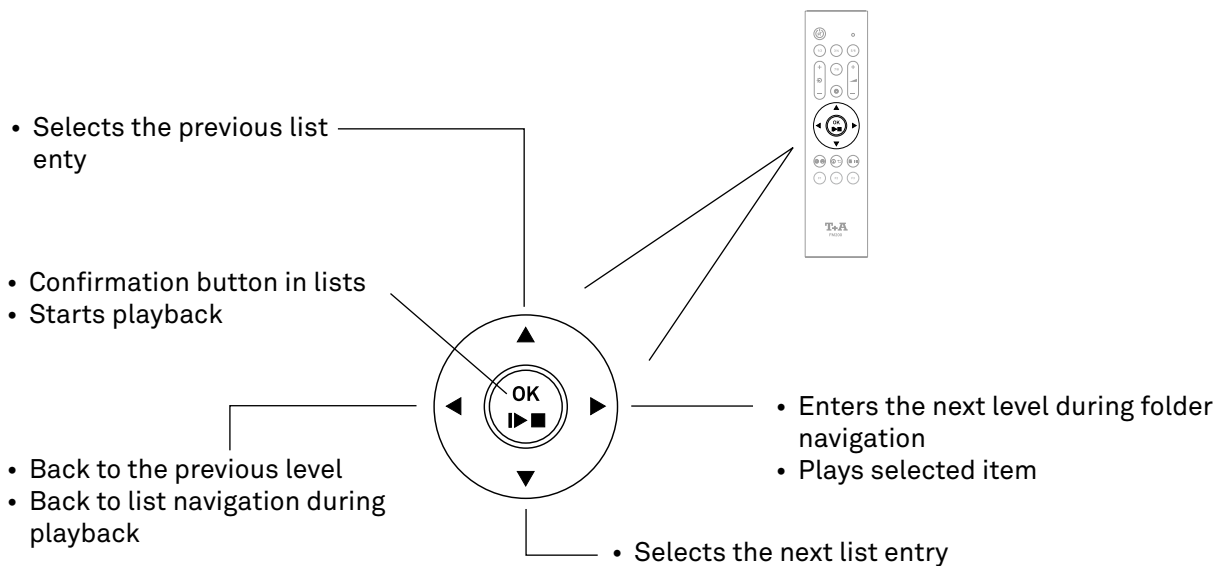

## Playback

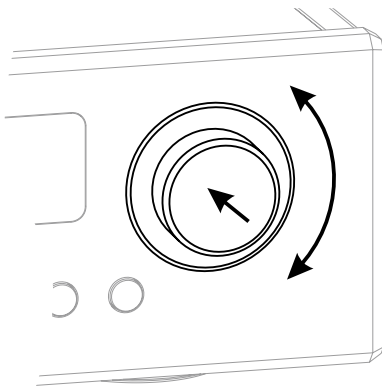

- A brief press on the SELECT knob starts playback.
- A brief press on the SELECT knob during playback pauses it.
- Press briefly again to resume.
- A long press on the SELECT knob stops playback.

Source FM, DAB and DISC:

- Turn the SELECT knob to select the next track/station.

All streaming sources:

- Turn the SELECT knob to return to the selection list during playback.
- Select the next desired title / station / podcast / etc. for playback and start playback by a brief press on the SELECT knob.

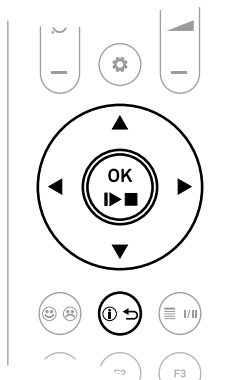

- A brief press on the button starts playback.
- Briefly pressing the button again during playback pauses it.
- To resume, press the button again briefly.
- A long press on the button stops playback.
- Use the buttons to select the next title / station during playback.

Source FM, DISC, UPnP, USB, Tidal and Qobuz:

- Press and hold one of the buttons to start the search in upward or downward direction.

By pressing the button on the remote control or the button on the MP 200, the display mode can be switched between a large format display with the most important information and a detailed view with smaller fonts and additional information such as bit rate etc.





# Connections

This and the following chapter describe all things of fundamental importance for installation and setup that are not relevant for the daily use of the device, but which should be read and observed before the first use.

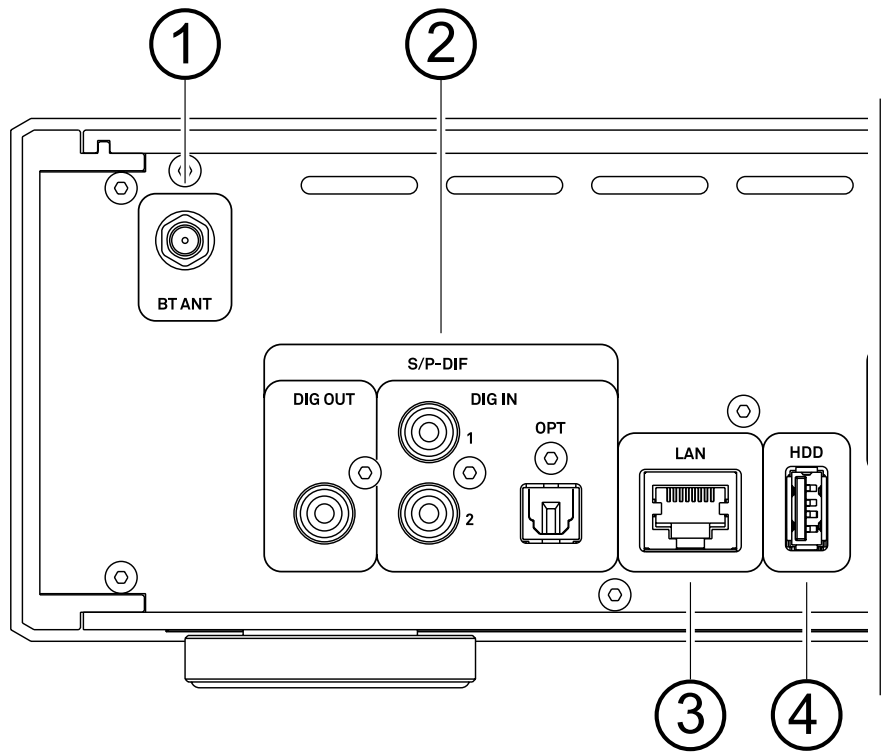

## ① Bluetooth antenna

BT ANT	Socket for connecting the bluetooth antenna.
--------	----------------------------------------------

## ② Digital In- and Outputs (S/P-DIF)

DIG OUT	The signals from the selected source are available at this socket. The data can be fed to another device such as a surround decoder or a DAC.
---------	-----------------------------------------------------------------------------------------------------------------------------------------------

DIG IN	Inputs for digital source devices with optical and coaxial digital outputs.
--------	-----------------------------------------------------------------------------

**i** The MP 200 accepts digital stereo signals at the inputs according to the S/P-DIF standard with sampling rates from 32 to 192 kHz.

## ③ LAN connection

LAN	Socket for connection to a wired LAN (Ethernet) home network.
-----	---------------------------------------------------------------

**i** If a LAN cable is connected this will have priority over wireless WLAN networks. The WLAN module of the MP 200 will automatically be disabled.

## ④ USB input

HDD	Socket for a USB memory stick or external hard discs The storage medium can be formatted with the FAT16, FAT32, NTFS, ext2, ext3 or ext4 file system. The USB storage medium can be powered directly via the USB port provided that its current drain is in accordance with the USB norm. Normalised 2.5" USB hard discs can be connected directly, i.e. without a separate mains PSU.
-----	----------------------------------------------------------------------------------------------------------------------------------------------------------------------------------------------------------------------------------------------------------------------------------------------------------------------------------------------------------------------------------------------

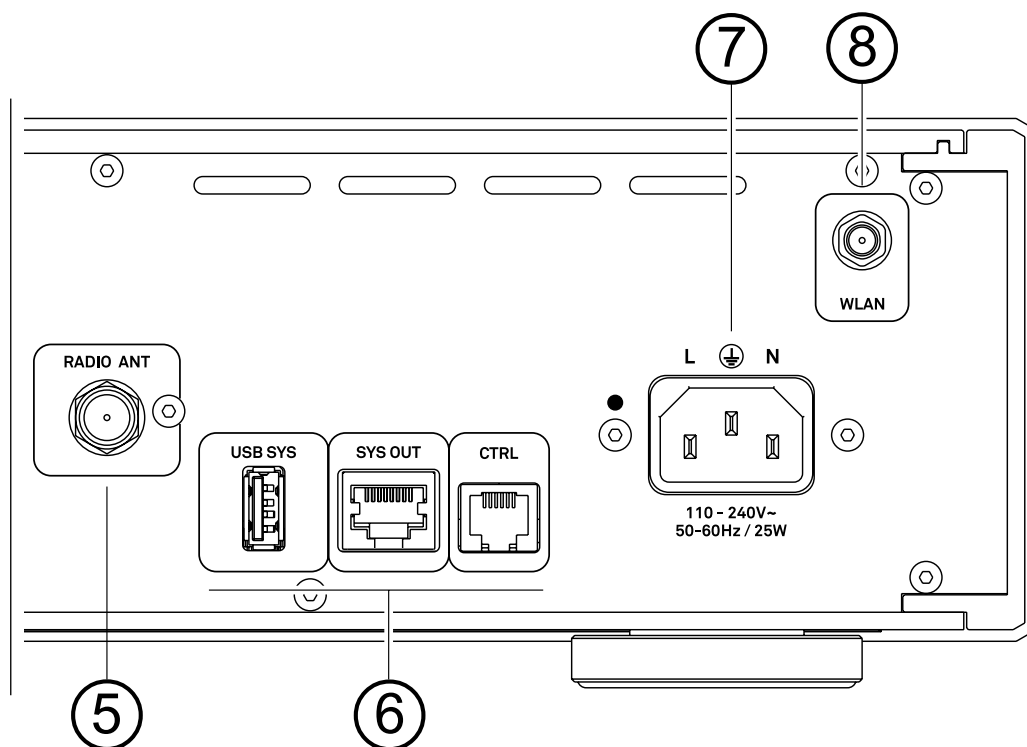

## ⑤ Radio antenna

RADIO ANT

This FM antenna input can be connected to a normal 75 Ohms FM home antenna or to TV/FM cable networks.

- i** The supplied antenna is suitable for receiving strong local stations. To receive weaker stations, a proper outdoor or roof antenna is required. For first-class reception quality a high-performance aerial system, competently installed, is a basic requirement.

## ⑥ System interfaces

USB SYS

Audio connection to the DAC 200 or HA 200. Connect this socket to the USB SYS connector on the DAC 200 or HA 200.  
For details please refer to the wiring diagram

SYS OUT

Control interface for operation with a DAC 200 or HA 200.

- i** If the MP 200 is operated in combination with a DAC 200 or HA 200, these sockets must be connected to the USB SYS and SYS IN socket of the DAC 200 or HA 200.

CTRL

Interface for later functions expansions.

## ⑦ Mains input

The mains lead is plugged into this socket.

## ⑧ WLAN socket

WLAN

Input socket for WLAN antenna

- i** If no wired LAN connection is found, the MP 200 will automatically activate its WLAN module and it will try to get access to your WLAN network.

# Installation and connection

## Installation

---

Carefully unpack the device and store the original packaging carefully. The carton and packing material are specially designed for this device and will be a safe container during any later transports. Set up the device at a proper place. Please observe all notes on connection and set-up in the chapter Safety notes (pages 10 and 11).

## Connection

---

To use the MP 200 with all its functions and sources, first you have to make some important connections and/or connect antennas.

The necessary connections are described below:

---

**⚠** *Do not connect the MP 200 and the other components to the power supply until all the necessary connections have been established.*

---

## WLAN antenna

---

To connect the MP 200 to your network (router) via WLAN, connect one of the two supplied antennas to the WLAN socket.

---

**i** *In case of poor reception conditions, the antenna can be mounted on the supplied antenna base and placed free-standing.*

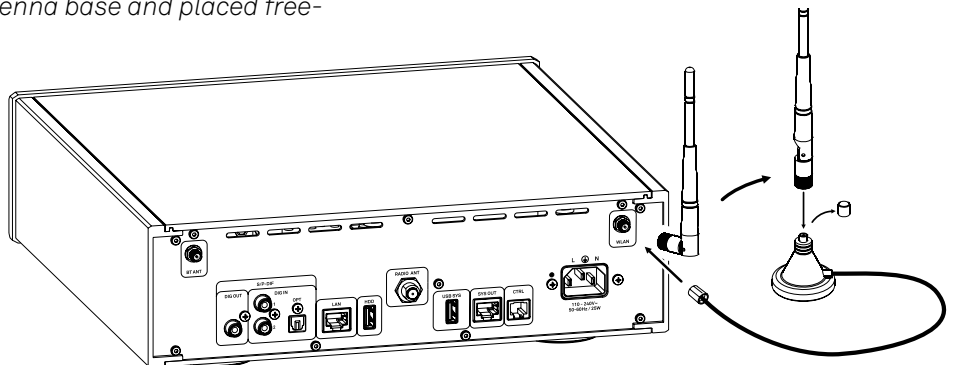

**i** *This antenna is not required if the device is connected to the Internet via a wired network (LAN).*

---

## LAN

---

For the connection to your network (router), connect the network cable to the LAN port.

---

**i** *When using the WLAN connection, this socket must remain free!*

## BLUETOOTH antenna

---

For audio streaming via Bluetooth, e.g. from a smartphone to the MP 200, one of the two antennas must be connected to the BT socket.

## Connection of digital source devices

---

At the digital inputs of the MP 200 (Digital IN) you can connect devices with electrical coax or optical fiber output.

 *The MP 200 accepts at all inputs digital stereo signals according to the S/P-DIF standard with sampling rates from 32 kHz to 192 kHz.*

## Connected to a DAC 200 or HA 200

---

The MP 200 is designed for operation in conjunction with the DAC 200 or HA 200. For this purpose, the MP 200 is equipped with the system interfaces USB SYS and SYS IN/OUT. If the MP 200 will be operated in conjunction with a DAC 200 or HA 200, these two interfaces must be connected. See also the wiring diagrams in the chapter Connection and cabling.

## Operation with other devices

---

For operation with other DACs or amplifiers, connect the DIG OUT digital output to the corresponding digital input of the device you are using.

## Connecting the power cord

---

Connect the mains cable to the mains socket of the MP 200 and then connect the device to the wall outlet. To achieve the maximum signal-to-noise ratio, the mains plug should be plugged into the wall outlet in such a way that the phase is connected to the contact of the mains input socket which is marked with a dot. The phase of the mains socket can be determined with a measuring device suitable for this purpose. Please contact your specialist dealer.

# Controls and functions

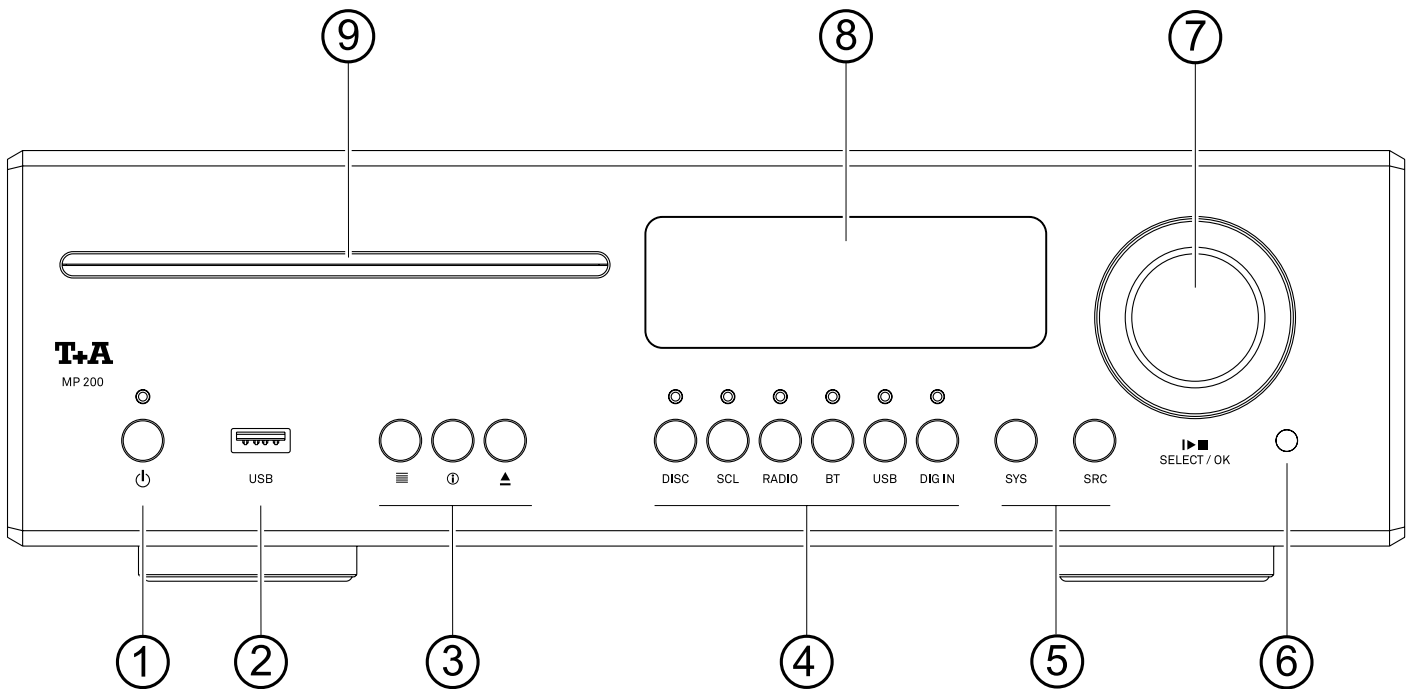

## ① On / Off switch



A brief press of this button switches the device on and off. When the device is switched on, the LED above the button lights up.

## ② Front USB socket

USB

Connection socket for a USB memory stick or an external hard drive

**i** The USB storage medium can be powered via the USB socket provided that its current drain meets the USB norm (< 500 mA). Normalised 2.5" USB hard discs can be connected directly to this socket, i.e. they require no mains PSU.

## ③ Function buttons



By a brief press on this button, the favorites list created on the MP 200 is called up. Presets for the sources FM radio, DAB radio and Internet radio can be saved in the list (please refer to the chapter Favourite lists).



By briefly pressing the button, you can cycle through the different display views. Detailed display with / without CD text / Radiotext (if present) and large display with / without CD text / Radiotext (if present).



A brief press will eject the inserted CD.

## ④ Source selection

DISC	Selects the CD player
SCL	Selects the SCL function (e.g. access to music servers, streaming services or similar). Press this button repeatedly until the desired source appears on the screen.
RADIO	Selects one of the following radio sources: FM / VHF (FM RADIO source), DAB (DAB RADIO source), Internet radio (Internet radio source) or Podcasts. Press this button repeatedly until the desired source is displayed on the screen.
BT	A brief press selects the bluetooth function of the MP 200.
USB	Selects the USB inputs for playback
DIG IN	A brief press on this button selects the digital input you wish to use. Press the button repeatedly until the desired input is displayed on the screen.

## ⑤ System and source menu

SYS	A brief press of the button calls up the menu for system settings. Details about the settings can be found in the chapter <i>Settings</i> .
SRC	Opens the setup menu for the currently selected source.

**i** *Not all sources have their own setup menu. For this reason, the button has no function for some sources.*

## ⑥ Remote control receiver

When operating by remote control, please point the FM200 in the direction of the receiver.

## ⑦ Menu operation and playback control

**SELECT / OK**  
||▶ □

By turning this knob, a title/track can be selected for playback. The selected title appears in the display. As soon as the desired title number lights up here, the title can be started by pressing the control knob. In addition to the title selection, the Select knob also has other functions such as navigation in lists, menu control, etc.

## ⑧ Display

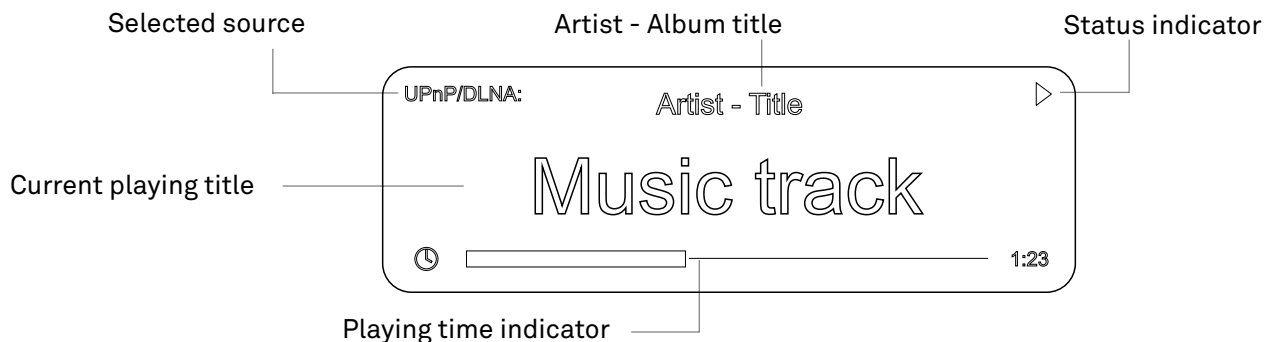

## ⑨ Disc drive

Feed slot for 12 cm discs. Insert the disc with the labeled side facing up until the disc feeds automatically.

**i** *The drive is designed to play standard 12 cm round discs only. Do not insert 8 cm discs or discs with unusual shapes. These may damage the drive.*

# Remote control

## On / Off Switch



A brief press switches the MP 200 on.  
Hold the button pressed in to switch the device off.

## Source selection

System network	Stand-Alone	Source
		DISC
		UPNP DEEZER QOBUZ TIDAL ROON READY
		FM DAB INTERNET RADIO PODCAST
		BLUETOOTH USB MEDIA DIGITAL IN 1 DIGITAL IN 2 DIGITAL IN 3

To select the desired source, press the corresponding source select button if necessary repeatedly.

### NOTE

Not required sources can be deactivated in the system settings for an even more comfortable source selection.

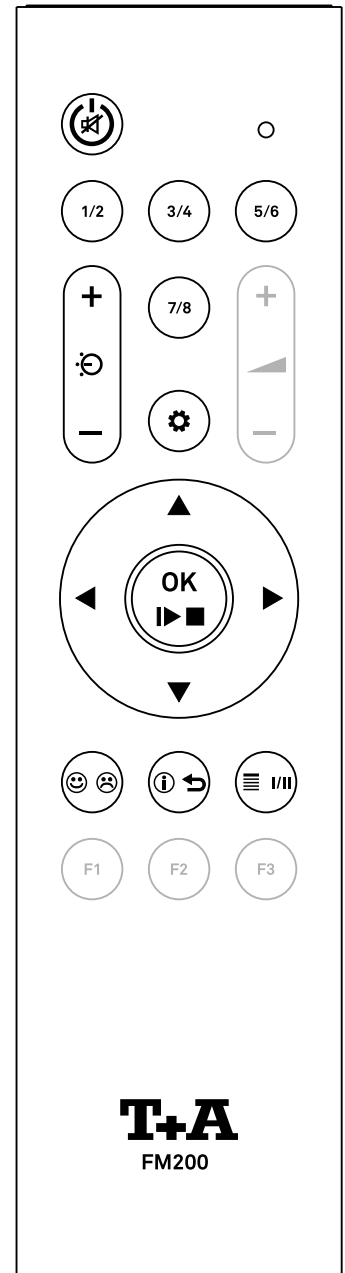

## Settings



A brief press  
Opens the menu for system settings (see page 28).

A long press  
Opens the menu with settings for the currently active source (not available for all sources).

## Playback and menu operation

- Confirmation button in lists.  
Starts playback.
- Pauses the current playback
- A long press stops playback and ejects the CD.
- Returns to list navigation during playback.
- Press and hold to search backwards.
- Selects the previous item within a list.
- Selects the next track/station during playback.
- Enter the next list level.
- Starts playback.
- Press and hold to search forward.
- Selects the next item within a list.
- Selects the previous track / station during playback.

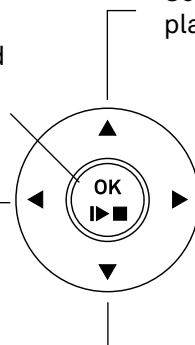





## Menu operation

Use the buttons ▲ ▼ to select an item in the menu.

Press the  button to activate the selected menu item.

Use the ◀ ▶ buttons to change the settings.

Press the  button to confirm the setting.

Press and hold the  button to return to the previous menu level.

## Alpha-numeric entry

To enter a source name, user data or network parameters, first activate the relevant input field with the  button.

If necessary, existing entries can be deleted by pressing the ◀ button repeatedly.

Press the ▲ ▼ buttons on the remote control handset: repeatedly until the desired letter appears on the screen. Briefly press the ▶ button to enter the next letter.

Press the  button to confirm the entry.

Use the  button for toggling between numbers, capitals and lower-case letters. The bottom line of the screen shows which input mode is currently selected.

### 1 2 3

1 2 3 4 5 6 7 8 9 0

### a b c

abcdefghijklmnopqrstuvwxyz -\*/^={ }([ ]<>.,?!:;\“’\_@\$%&# ~ 0 1 2 3 4 5 6 7 8 9

### A B C

ABCDEFGHIJKLMNOPQRSTUVWXYZ -\*/^={ }([ ]<>.,?!:;\“’\_@\$%&# ~ 0 1 2 3 4 5 6 7 8 9

## Function buttons

---



A brief press

Adds a favorite to the favorites list

In the system configuration menu: Activates a source

A long press

Removes a favorite from the favorites list.

In the system configuration menu: Deactivates a source



A brief press

Cycles through the various screen displays.

Detailed display with / without CD text / Radiotext (if present) and large display with / without CD text / Radiotext (if present).

Switches between capitals and lower case, and numeric / letters, when entering data.

A long press

When necessary, repeated long presses of the button cycle through the various playback modes (repeat track, repeat whole disc, etc.).



A brief press

Calls up the Favorites / Presets list for the currently active source (not available for all sources).

A long press

Switching between stereo and mono reception (only available for FM radio)

## Replacing the battery

To change the battery of the remote control, first remove the two screws shown in Figure 1. Then remove the battery holder by pulling it downwards. Insert a new CR 2032 battery into the battery holder according to the marking (+ on the battery facing downwards). Now insert the holder as shown and use two screws to fasten the holder.

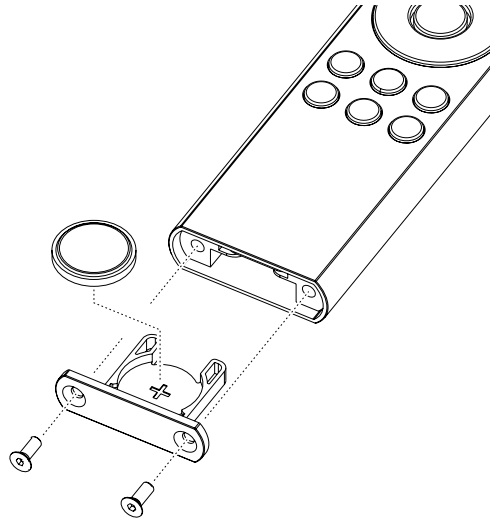

## Range

When operating by remote control, please hold the FM200 in the direction of the remote control receiver. The range of the remote control is approx. 4..5 m. The line of sight between FM200 and the remote control receiver must not be interrupted by obstacles. The direct incidence of interfering light (e.g. from fluorescent and energy-saving lamps) into the receiver should be avoided at all times, as otherwise the range of the remote control can be considerably reduced.

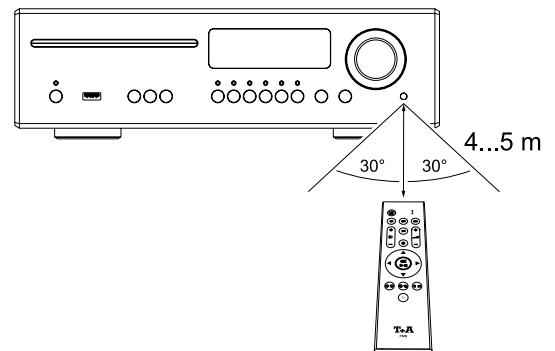

## Important information



*The remote control handset supplied in the set contains a button cell battery.*



**Do not swallow the battery: chemical burn hazard. If this button cell is ingested, within two hours it may cause serious internal chemical burning which could result in death**

- **If you suspect that someone might have swallowed a battery, or that a battery could have entered any part of the body, seek immediate medical assistance.**
- **If the battery is replaced improperly, there is danger of explosion. Always replace batteries by batteries of the same or an equivalent type.**
- **Keep new and used batteries well away from children.**
- **If you cannot close the battery compartment securely, cease using the product, and keep it away from children.**
- **Batteries should not be exposed to excessive heat like sunshine, fire or the like.**
- **Very low air pressure may result in explosion of the battery, or leakage of flammable liquids or gases.**
- **Protect the remote control from humidity, coldness, heat and dust.**
- *Exhausted batteries must never be thrown into the household waste! They should be returned to the battery vendor (specialist dealer) or your local toxic waste collection point, so that they can be recycled or disposed in a proper way. Most local authorities provide collection centres for such waste, and some provide pick-up vehicles for old batteries.*

# Settings

## Menu operation







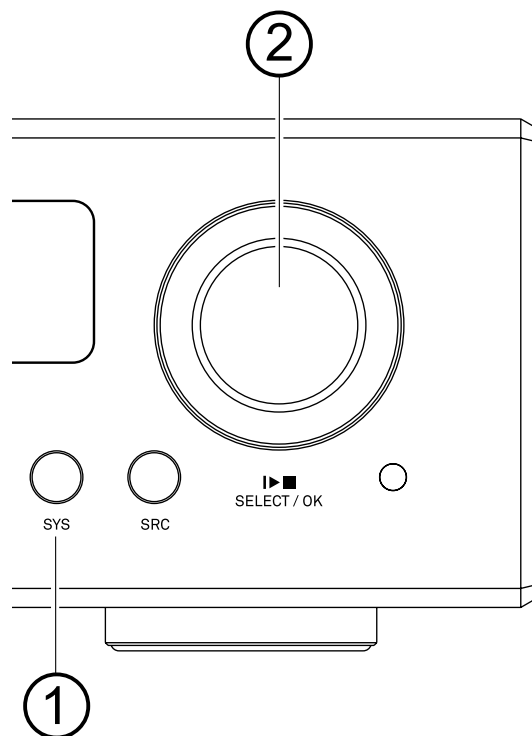



---

### Operation on the device

- To call up the **system settings** menu, press the SYS button ① on the front of the MP 200.
- Select an item in the menu with the SELECT knob ②.
- To change a selected menu item, confirm by pressing the SELECT knob and then change it by turning the knob.
- To confirm the setting, press the knob again after the change.
- To cancel a change, you can always press the SELECT button for a long time or briefly press the SYS button.
- By pressing the SELECT knob for a long time, you can return to the previous menu level.
- To exit the menu, press the SYS button.



### Operation by remote control

- To open the system settings menu, press the  button on the remote control.
- Use the buttons   to select an item in the menu.
- To change a selected menu item, first press the  button and then use the   buttons to alter the setting.
- To confirm the setting, press the  button again after changing it.
- To cancel a change, you can always abort by a long button press on  or by a brief press on the  button.
- Press and hold the  button to return to the previous menu level.

To exit the menu, press the  button..

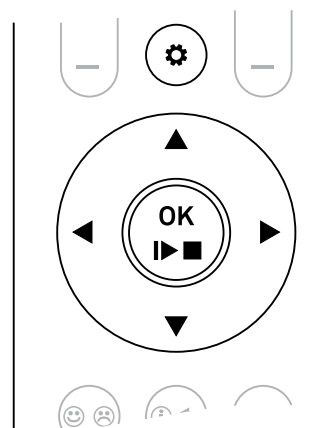

# System settings

---

## Source configuration

At this menu item you can activate and disable not used sources, and assign a plain text name to each source; this name then appears in the screen displays.

You can also assign a plain text name for the display to the external sources (digital inputs and Bluetooth).

When this menu item is called up with the  button, a list of all sources of the MP 200 appears.

Each source is followed by the displayed plain text name or the note *Enabled* for an active source or *Disabled* if the source is deactivated.

### Deactivate not required sources

A long press on the  button deactivates the selected source.

To activate a source, press the  button briefly.

### Change the source name

To change the plain text name, first select the corresponding source and press the  button.

Delete the previous name by repeatedly pressing the  button.

Enter the new name using the cursor keys.

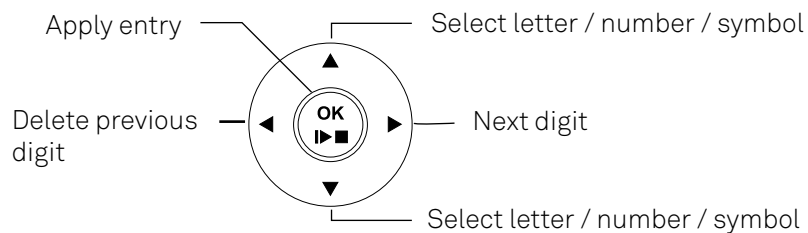

To switch between numeric and alphanumeric input as well as upper/lower case, press the  button.

If you should wish to restore the factory default source name, erase the whole name before saving the empty field with the  button: this action resets the display to the standard source names.

---

 *These settings can only be changed by using the remote control.*

---

## Display brightness

At this point you can adjust the brightness of the integral screen to suit your personal preference for normal use.

---

## Display mode

Here you can set whether the display will be switched on permanently or only temporarily, when the device is being operated.

If the setting *temporary* is selected, the display is switched on during operation of the MP 200 only and then automatically switched off again after a short delay.

If the *Always ON* setting is selected, the display remains permanently on.

---

---

**Colour profile** Under this menu item you can adjust the brightness of the status LEDs and the brightness and illumination color of the meters to your personal preferences.  
Select the menu item *Default colours* to reset the displays to the default settings.

---

**Language** In this menu item you define the language to be used for the displays on the screen of the front panel of the MP 200.  
The language used for data transferred to the machine, e.g. from an iPod or other Internet radio station, is determined by the supplying device or the radio station; you cannot define the language on the MP 200.

---

**Device name** This menu point can be used to assign an individual name to the MP 200. In a home network the device then appears under this name.

---

**Energy saver** The energy saving mode can be switched on and off here.  
The machine has an Auto Power Down function.  
If the *ECO* option is selected, the MP 200 automatically switches to standby mode if no music signal and no operation is detected for more than 90 minutes.  
If the *Comfort* setting is selected, the unit remains switched on until it is manually switched to standby mode.

---

 In countries outside the EU where the EuP directive does not apply, the automatic power-off function of the device (ECO setting) can be deactivated if required.

---

**Network** All network settings can be carried out at this menu point. For a detailed description on setting up a LAN or WLAN connection please also refer to the section entitled *Network configuration* on page 31.

---

**Music services** At this point you can enter the access data for the music streaming services **Qobuz** and **Deezer**.  
**TIDAL** uses a special procedure for entering the access data. For this reason, the data must be entered via the T+A Music Navigator app (please see next page for details). If necessary, you can delete them later under this menu item.

**Entering the user name and password**

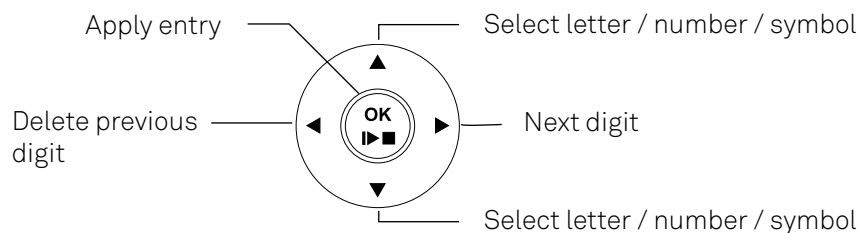

To switch between numeric and alphanumeric input as well as upper/lower case, press the  button.

To store the credentials, select the menu item *Store and exit?* and press the  button.

**Deleting the credentials**

You can delete the user data completely by selecting the menu item *Remove login and exit?* and confirm by pressing the  button.

---

---

## TIDAL credentials

To enter the TIDAL credentials, open the T+A Music Navigator App and select the TIDAL source. Are no credentials stored, an internet browser with the TIDAL log-in window will open automatically. Enter your credentials here and confirm the entry. As soon as the login has been successfully completed, you can close the Internet browser and return to the T+A app. Your data is now automatically saved and TIDAL is available.

---

 We recommend that you enter your TIDAL credentials via our app.

*If no mobile device is available, the procedure can alternatively be carried out via the Internet browser of your PC. For this, call up the TIDAL source on the MP 200 and press the *i* button on the remote control or on the device. An Internet address and an activation code are displayed on the MP 200. Enter the address in the browser and open the page. Enter the activation and confirm. You will be automatically redirected to the TIDAL log-in page. Log in here with your credentials. The device is now logged in to TIDAL.*

---

---

## Bandwidth limit

This menu point can be used to adjust the link speed of the Internet connection. The bitrate of the Internet radio stations and streaming services is adjusted automatically to match your chosen setting. If you select *no limit* for bandwidth limit, the highest available quality is always selected automatically.

---

---

## Device info

At this menu point you will find information on the status of the installed software and the factory reset.

---

Update                      A firmware update can be started here

---

Update package            This point displays the currently installed software package

---

Main                         Display of the main control processor software version

---

Client                        Display of the streaming client software version

---

DAB/FM                     Display of the tuner software version

---

Decoder                     Display of the disc decoder software version

---

Bluetooth                  Display of the bluetooth software version

---

Bluetooth pairings        All existing Bluetooth pairings can be deleted under this menu item

---

Factory settings            By calling up and confirming this menu item, all personal settings are deleted and the delivery status is restored

---

Legal information         Information on accessing the legal information and license notices

---

# Network configuration









## General information

All network settings are carried out in the system settings under the menu item Network.

If the MP 200 is not connected to a wired network via its LAN port, the WLAN module is activated and the the Network menu displays the menu items for setting up the WLAN connection.

**i** If you want to connect the MP 200 to the home network via WLAN, the LAN port must remain free.

## Menu operation

- Open the system settings menu by pressing the  button on the remote control.
- Select the Network menu item with the   buttons and confirm with the  button.
- In the network menu, select the network parameter to be changed with the   buttons and activate the entry with the  button.
- Now you can change the setting depending on the type with the following buttons:
  - ◀ ▶ buttons at simple selection (ON/OFF)
  - ▲ ▼ buttons at IP addresses and alphanumeric input of text.
- After the setting has been made or the address has been entered completely, confirm the entry with the  button.

**i** The network parameters can only be set using the remote control.

## Connection via LAN (cable connection)

- Connect the MP 200 to an operational network (router) or power line modem via the rear LAN port.
- Switch on the MP 200.
- Usually, an IP address is automatically assigned to the MP 200 by your router (via DHCP) and the MP 200 is ready for operation after the start-up process of the streaming module.
- If this is not the case, open the network menu (Network) and set the network parameters listed below according to your network settings.

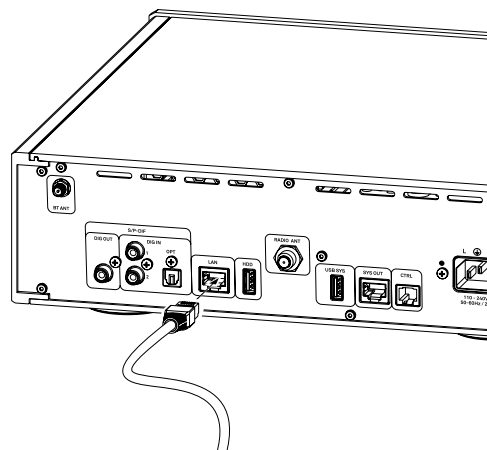

Menu item	Setting / Explanation
MAC	The MAC address is a hardware address which uniquely identifies your machine. The address displayed is determined by the manufacturer, and cannot be altered
Connction state	Shows the connection state: WLAN, LAN or not connected

<b>DHCP</b>	<p><b>on</b></p> <p>If your network includes a DHCP server, please select the ON setting at this point. In this mode an IP address is automatically assigned to the MP 200 by the router. The screen shows only the MAC address and the message DHCP state ON. In this case the address input fields shown in the illustration do not appear in the menu.</p> <p><b>off</b></p> <p>If your network does not include a DHCP server, please select the OFF setting. In this mode you must configure the following network settings manually. Please ask your network administrator for the addresses to be entered for your network.</p>
<b>IP</b>	IP Address of the MP 200
<b>Subnet mask</b>	Network mask
<b>Gateway</b>	IP Address for the router
<b>DNS</b>	Name / IP of the name server (optional)
<b>Store and exit?</b>	Stores the network parameters, and restarts the MP 200 with the new settings
<b>Discard and exit?</b>	Closes the menu: data already entered is discarded

## Connecting to WLAN (radio connection)

- Connect the supplied WLAN antenna to the WLAN socket on the back of the MP 200. Depending on your reception and set-up situation, the antenna can be mounted directly on the socket on the back or together with the magnetic base supplied (see fig.).
- Switch on the MP 200.
- Open the menu for system settings and then the menu item Network.

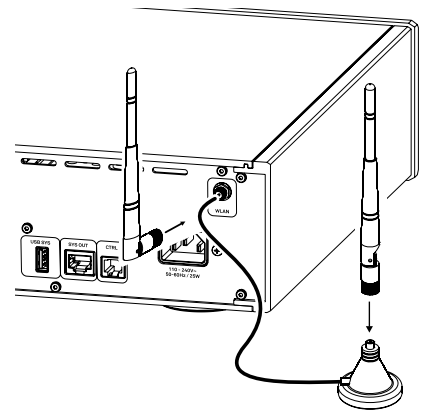



Menu item	Setting / Explanation
<b>MAC</b>	The MAC address is a hardware address which uniquely identifies your machine. The address displayed is determined by the manufacturer, and cannot be altered.
<b>Connction state</b>	Shows the connection state: WLAN, LAN or not connected.
<b>WPS autoconnect</b>	Activates the WPS function to connect the MP 200 to the WLAN via WPS. See chapter <i>Setup via the WPS function</i> .
<b>Scan for WLAN</b>	Starts the scan for WLAN networks that are within reception range.
<b>WLAN access point</b>	Starts the access point mode to set up the WLAN connection via the T+A App <i>TA Music Navigator</i> . See chapter <i>Configuration via Access Point</i> .

**i** All other menu items are the same as for the connection via LAN. See above for more information.







---

## Configuration using the WPS function

- First activate the WPS-function of the Router or Repeater to which you wish the MP 200 to be connected. For details please refer the manual of the device in question.
- Start the WPS-Autoconnect function of the MP 200 within 2 minutes.
- Use the ▲ ▼ buttons to select the menu point “WPS-Autoconnect”, then confirm your choice with the  button.
- After the connection is established, the line Status shows the connected WLAN network.
- Finally select the “Store and exit?” menu point and press the  button to accept the settings.

---



## Manual setup of the WLAN connection

- First select the Scan for WLAN menu item and confirm it with the button.
- A list of the WLANs found appears.
- Use the ▲ ▼ buttons to select the WLAN to which you wish the MP 200 to be connected, and confirm your choice with the  button.
- Enter the network password (passphrase) and confirm your entry with .
- Confirm and store the settings by selecting the item *Store and exit?* and pressing .
- Finally, select the menu item *Store and exit?* again and confirm the settings with the  button again.

---

## Setting up the WLAN connection via the T+A app (TA Music Navigator)

The MP 200 supports setting up the WLAN connection via an access point. This means that the MP 200 provides its own WLAN for the duration of the configuration of the WLAN settings. As soon as the configuration is complete, this WLAN is deactivated again. The MP 200 restarts and connects to the WLAN configured via the app.

- Turn on the MP 200 and open the system configuration menu by pressing the  button on the remote control or the SYS button on the front of the MP 200.
- Use the ▲ ▼ buttons to select the menu point Network, then confirm your choice with the .
- Use the ▲ ▼ buttons to select the menu point Access Point, then confirm your choice with the  button.
- The MP 200 activates the WLAN access point.
- The following steps must be performed within approximately 5 minutes. After this time, the MP 200 will exit access point mode automatically.
- Connect the smartphone or Tablet PC on which the T+A-app is installed to the WLAN access point. The network name (SSID) is „T+A AP MP 200“ and the passphrase is “01234567”.
- Start the T+A-app for operation.
- The app recognizes the access point and starts automatically with the setup wizard.
- To set up the WLAN, go through the individual steps of the app’s setup wizard.
- Quit the app, then connect your phone or tablet to your previously set up wireless LAN.
- After restarting the app the MP 200 will be detected automatically.
- Once the MP 200 is detected, it can be selected for playback.

# Source operation

## Selecting a source

---

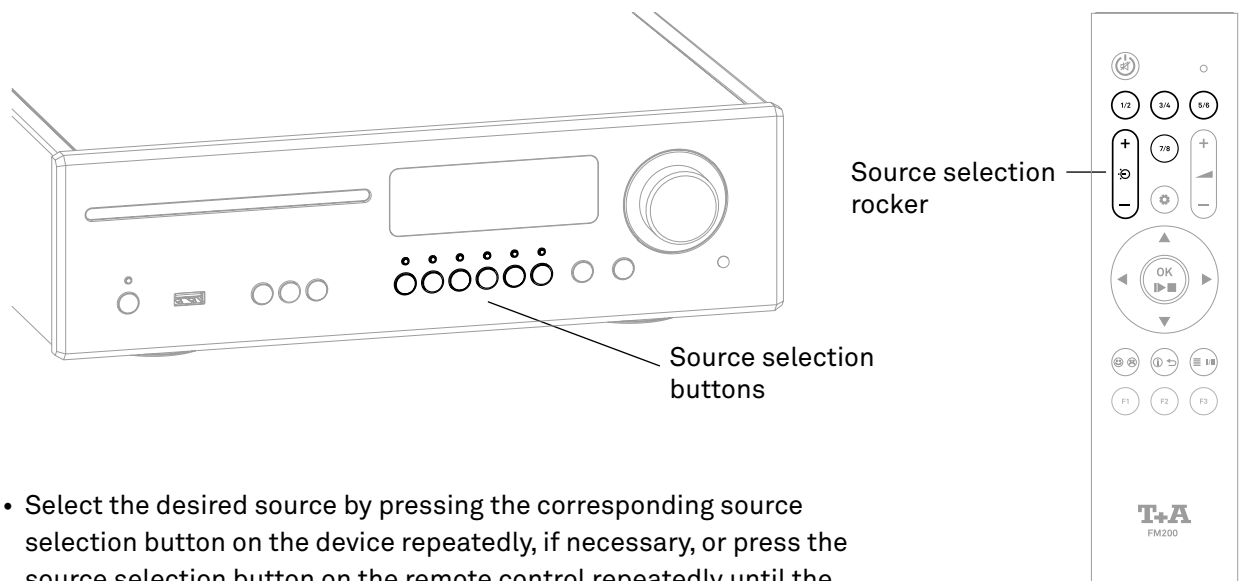

- Select the desired source by pressing the corresponding source selection button on the device repeatedly, if necessary, or press the source selection button on the remote control repeatedly until the source is shown in the display.
- When operating the MP 200 without a DAC 200 or HA 200, the source can alternatively be selected via the  $\textcircled{1/2}$  ...  $\textcircled{7/8}$  buttons on the remote control (press) repeatedly if necessary.

---

**i** If the MP 200 is operated in a system network with a DAC 200 or an HA 200, the source selection buttons  $\textcircled{1/2}$  ...  $\textcircled{7/8}$  of the remote control are used for the source selection of the DAC 200 or HA 200 sources. In this case, source selection at the MP 200 via remote control is done exclusively via source selection rocker.

---

For a faster and more convenient source selection, not required sources can be deactivated in the system settings. See chapter **System settings**.

---

As soon as you have selected the desired source on the MP 200, a connected DAC 200 or HA 200 automatically selects its system input for playback. The display of the DAC 200 or HA 200 now shows SYS IN.  
If the MP 200 is already set to the correct source, but another source has been selected for playback on the DAC 200 or HA 200 in the meantime, it is possible to switch to the system input of the DAC 200 or HA 200 by briefly pressing the source selection button of the MP 200 once again.

## Browsing through lists

---

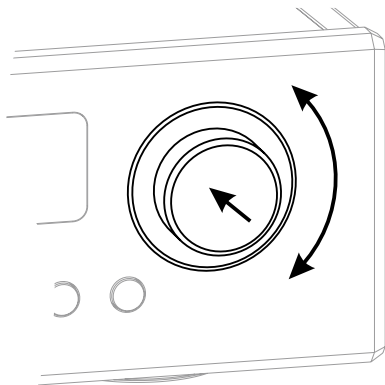

- A folder/title/station/favorite can be selected by turning the SELECT knob on the front panel. The selected list entry is displayed in enlarged form.
- The selected list entry can be opened or played by pressing the SELECT knob depending on the type (folder/title/station etc.).
- A long press on the SELECT knob takes you back to the previous level (if available).

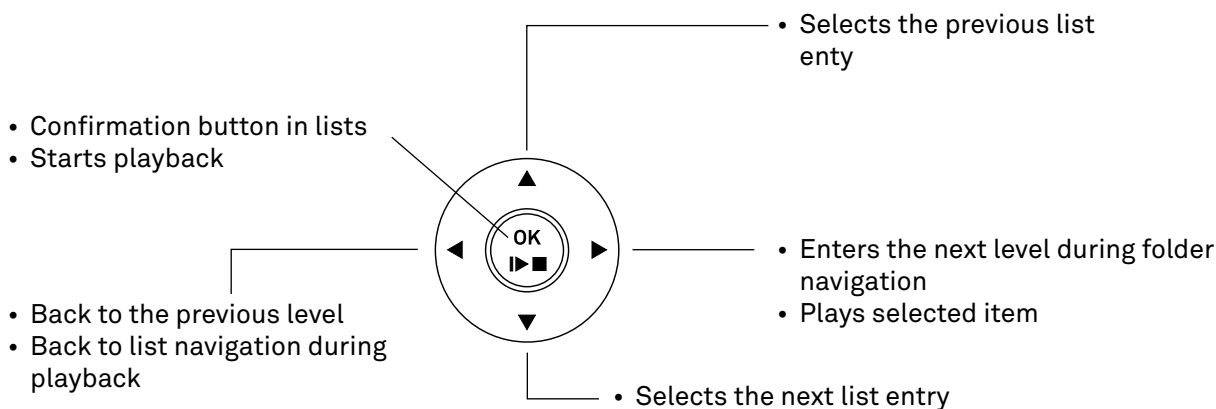

## Playback

---

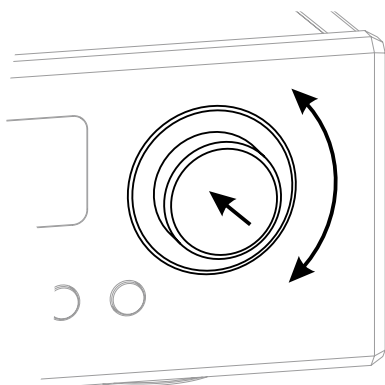

- A brief press on the SELECT knob starts playback.
- A brief press on the SELECT knob during playback pauses it.
- Press briefly again to resume.
- A long press on the SELECT knob stops playback.



Source FM, DAB and DISC:

- Turn the SELECT knob to select the next track/station.

All streaming sources:

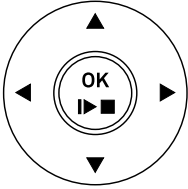
- Turn the SELECT knob to return to the selection list during playback.
- Select the next desired title / station / podcast / etc. for playback and start playback by a brief press on the SELECT knob.



- A brief press on the  button starts playback.
- Briefly pressing the button again during playback pauses it.
- To resume, press the  button again briefly.
- A long press on the  button stops playback.
- Use the ▲ ▼ buttons to select the next title / station during playback.

Source FM, DISC, UPnP, USB, Tidal and Qobuz:

- Press and hold one of the ◀ ▶ buttons to start the search in upward or downward direction.

## Display

The MP 200 features different screen views for the internal sources (streaming, CD player radio sources, Bluetooth and USB) for playback

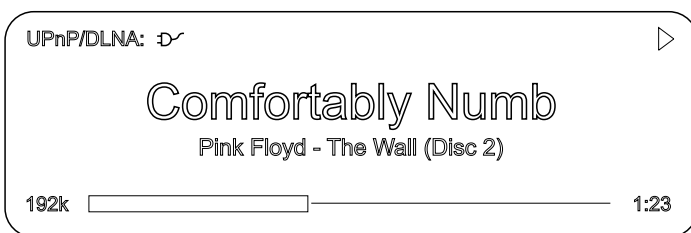

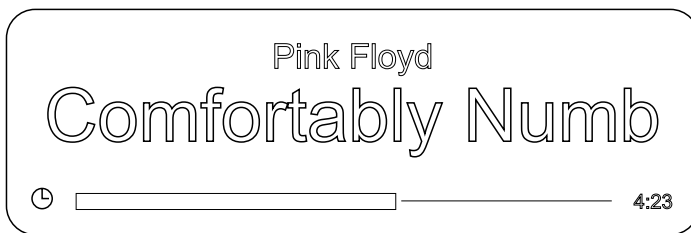

### Detailed view:

Display with smaller font and a lot of additional information like bitrate etc.



### Enlarged view:

Large-format display of the most important information, easy to read even from a greater distance.

You can toggle between the display modes by pressing the  button on the front of the MP 200 or by pressing the  button on the remote control. The change of the setting is only visible during playback.

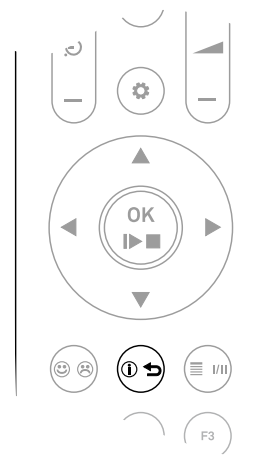
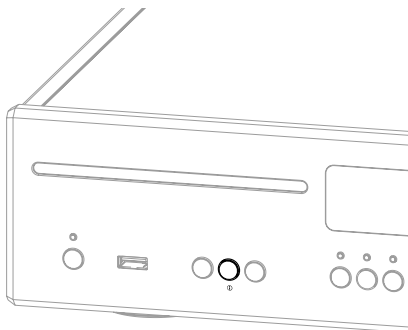



# Favourites list

## General information

---

The MP 200 includes the facility to create Favourites lists. The purpose of these lists is to store radio stations and podcasts, so that they can be accessed swiftly.

Each of the sources FM radio, DAB radio, and Internetradio features its own Favourites list.

Once stored, the favourites can either be selected from the Favourites list, or called up directly by entering the program location number. The option of selecting using the location number is particularly useful when you wish to call up favourites when the screen is not in view (e.g. from an adjacent room) or using a house control system.

---

- i** *Favourites lists for the various music services (TIDAL etc.) are not supported. Instead it is usually possible to add Favourites and Playlists on-line via the provider's account. These can then be called up and played via the MP 200.*

## Calling up the Favourites list

---

- The first step is to switch to one of the sources listed above.
- Press the  button to call up the Favourites list.

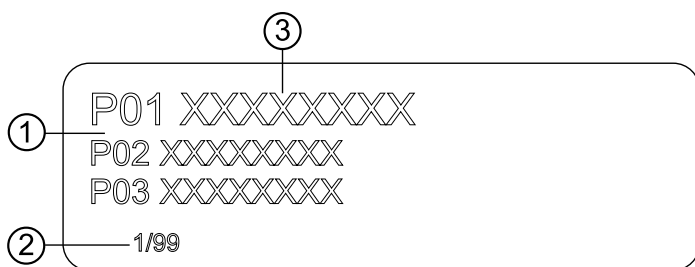

- ① Here the program location number is displayed within the list. Since it is possible to erase individual list items, the numbering may not be continuous.
- ② Position display in the Favourites list.
- ③ The selected list entry is displayed in enlarged form.





## Adding a favourite

---

If you especially enjoy the piece of music or radio station to which you are currently listening, simply press the  button on the remote control; this action stores the station in the corresponding Favourites list.



## Erasing a favourite from the Favourites list



---

Open the Favourites list by pressing the  button. Use the   buttons to select the station in the list which you wish to erase, then hold the  button pressed in; this action removes the item from the Favourites list.

## Play Favourites

---

Call up the favourites list by pressing the  button on the remote control or the  button on the MP 200's front panel.







Select a stored favourite from the favourites list using the   buttons or by turning the SELECT knob on the MP 200. The selected favourite is displayed enlarged.

By pressing the  button or by pressing the SELECT knob, the favourite is selected for playback.





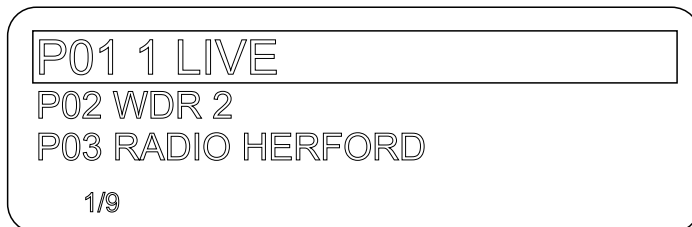

## Sort Favourites

---

The sequence of items in the Favourites list you have created can be altered in any way you wish. This is the procedure for changing the order of the list:

- First, call up the Favourites list by briefly pressing the  button on the remote control or the  button on the MP 200.
- Select the favourite that you wish to change the position of with the   buttons on the remote control or by turning the SELECT knob on the MP 200. The selected favourite is displayed enlarged.
- Pressing the  button on the remote control or the  button on the MP 200 activates the sort function for the selected favourite. The favourite is highlighted.



- Now move the activated favourite to the desired position in the favourites list using the   buttons on the remote control or by turning the SELECT knob on the MP 200.
- Pressing the  /  key again deactivates the sorting function. The favourite is now stored at the new position.
- The favourite is now stored at the new position. To close the favourites list, briefly press the  /  button again.

---

 *If you have previously erased a number of favourites, you may well find that some program locations in the Favourites list are missing (empty). Nevertheless, the favourites can still be moved to any location in the list!*

# Radio operation

## General information

The MP 200 features an FM Tuner (VHF radio) with HD Radio™ technology\*, a DAB / DAB+ reception section (digital radio) and also includes the facility to stream Internet radio. The following section describes in detail how to operate the individual radio sources.

HD Radio technology enables radio stations to transmit analogue and digital programmes on the same frequency simultaneously.

The integral DAB+ receiving section is backwards-compatible with DAB, to ensure that you have access to a wide range of stations.



\* HD Radio™ technology only available in US-version.

## FM Radio

Press the RADIO button on the front panel of the MP 200 or the  button on the FM 200 remote control repeatedly if necessary until the source FM Radio is shown in the display.

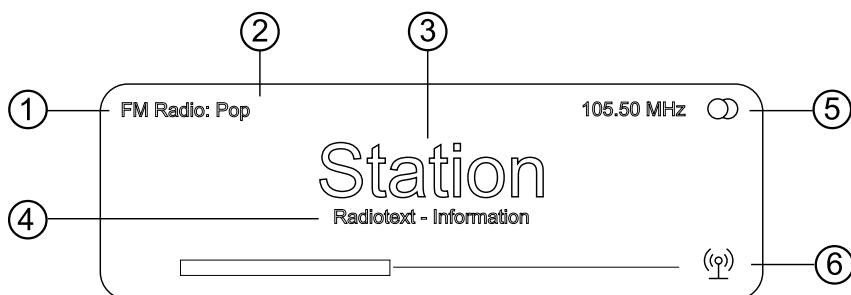
## Display



- ① Displays the selected radio source.
- ② Here the music type or style is displayed, e.g. Pop Music.  
This information is only displayed if the transmitting station broadcasts it as part of the RDS system. If you are listening to a station which does not support the RDS system, or only supports it in part, these information fields remain empty.
- ③ The frequency and / or the station name is displayed in enlarged form. If a station name is displayed, its frequency is shown in area ⑤.
- ④ These lines display information which is broadcast by the station (e.g. Radiotext).
- ⑤ Display of Stereo  /  Mono
- ⑥ The field strength and therefore the reception quality to be expected from the set transmitting station can be assessed from the field strength.

FM Radio: when receiving an HD Radio broadcast, here the currently selected programme from the total number of programmes available is displayed too (left side), e.g. programme 2 of total 3 available.



## Manual station search

---

### Operation by remote control

Press and hold one of the ◀ ▶ buttons on the remote control to start the station search in upward or downward direction. The station search stops automatically at the next station found. By repeatedly short presses on the buttons on the remote control, it is possible to select a specific frequency.

Once the desired station has been selected, it can be added to the Favourites list by pressing the Ⓜ button. (see also chapter „Favourite lists“)

---

### Operation at the device

Manual selection of a specific frequency is also possible via the SELECT knob on the device. By pressing the SELECT knob several times, if necessary, you can switch between the functions of the SELECT knob for a short time. The currently selected operating mode is shown at the bottom left of the display (only in the detailed display setting). The following functions can be selected:

Display indicator	Function
Freq	Manual frequency tuning
Fav	Selecting a stored favourite
None (Standard setting)	Selecting a station from the station list
HD	HD Radio programme selection (if available)

**i** The method of searching for an HD Radio station is the same as for an analogue FM station search. As soon as you select a station with a HD Radio programme, playback automatically switches to the digital programme.

## Automatic station search

---

A brief press on the SRC button on the MP 200's front panel or a long press on the ⚙ button on the remote control opens the station list menu. The following menu items are available:



- If you wish to create a new station list, select the item “Create new list” and confirm your choice with Ⓜ.
- The station search begins, and automatically searches for all radio stations which the machine is able to pick up.
- If you wish to update an existing list, select the item “Add new stations”.
- The menu item “Sort stations by ...” allows you to sort the stored list by any of several criteria.

## Mono / Stereo selection

---

By a long press on the Ⓜ button of the remote control, the FM tuner of the MP 200 can be switched between stereo and mono reception. The reception mode is shown in the display:

## Switching Radio text on and off

---



The Radio text function can be switched on and off by briefly pressing the Ⓜ button on the remote control handset.

## DAB Radio

Press the RADIO button on the front panel of the MP 200 or the  button on the FM 200 remote control repeatedly if necessary until the source DAB Radio is shown in the display.

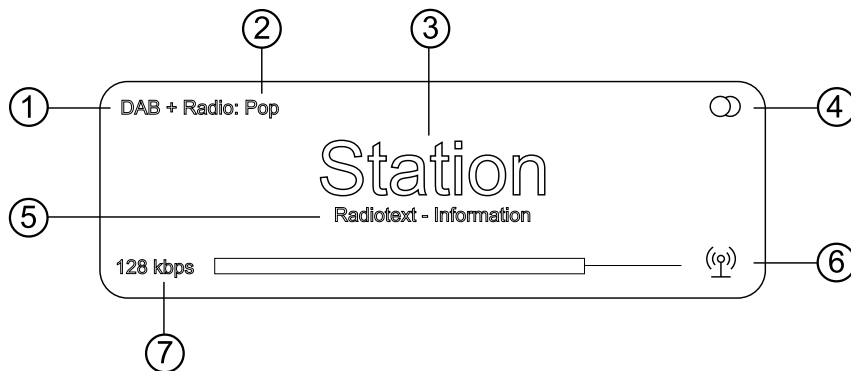
## Display



- ① Displays the selected radio source.
- ② Here the music type or style is displayed, e.g. Pop Music.  
This information is only displayed if the transmitting station broadcasts it as part of the RDS system. If you are listening to a station which does not support the RDS system, or only supports it in part, these information fields remain empty.
- ③ Display of the station name
- ④ Display of Stereo  /  Mono
- ⑤ These lines display information which is broadcast by the station (e.g. Radiotext).
- ⑥ The field strength and therefore the reception quality to be expected from the set transmitting station can be assessed from the field strength.
- ⑦ Bit-rate of the broadcasting station when listening to DAB radio.  
\* The higher the bit-rate, the better the station's sound quality.

## Automatic station search

A brief press on the SRC button on the MP 200's front panel or a long press on the  button on the remote control opens the station list menu. The following menu items are available:



- If you wish to create a new station list, select the item "Create new list" and confirm your choice with .
- The station search begins, and automatically searches for all radio stations which the machine is able to pick up.
- If you wish to update an existing list, select the item "Add new stations".
- The menu item "Sort stations by ..." allows you to sort the stored list by any of several criteria.

## Internet Radio

---

Press the RADIO button on the front panel of the MP 200 or the  button on the FM 200 remote control repeatedly if necessary until the source Internet Radio is shown in the display.

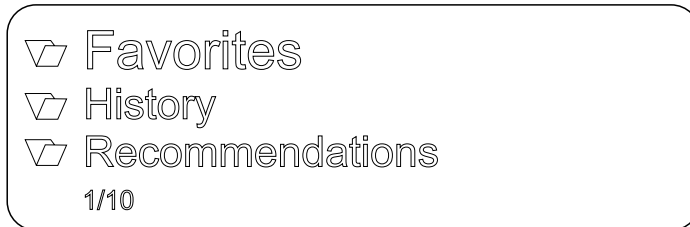

## Display

---





## Search function

---

- Select the entry *Search* in the selection list with the ▲ ▼ buttons and confirm with the  button.
- A pop-up window with the message *Search* appears in the display. While the pop-up window is displayed, enter a letter using the ▲ ▼ buttons on the remote control. Press the button repeatedly until the desired letter appears in the display.
- To enter the next letter, press the ► button.
- To delete a letter, press the ◀ button.
- Press the  button to start the search.
- After a short delay, a list with the search results appears.

## Favorites

---

In addition to the Favorites list provided by the device (see also chapter Favorites lists on page 38), the Internet radio source also has a Favorites folder in the root folder of the Internet radio source. This favorites folder is provided by the Internet radio provider and is independent of the favorites list in the device. To save a favorite in this folder, tap the  icon in the T+A Music Navigator app during playback. To delete the favorite from the folder, tap the  icon.

# UPnP, Music services and USB

## General information

The MP 200 includes a streaming client (SCL).

This enables music playback from network servers (NAS), a directly connected USB storage device or music streaming services e.g. Tidal and Qobuz.

**i** To make use of music services you may need to take out a paid subscription with the appropriate provider.

Use of music services requires the input of access data (username and password. These access data can be stored separately for each provider in the **Music services** menu item within the settings menu (Page 29).

The memory medium can be formatted with any of the following file systems:  
FAT16, FAT32, NTFS, ext2, ext3 or ext4.

The exact form of the list format and the preparation of the content depends mainly on the capabilities of the server / music streaming service.

## Source selection

Press the SCL button on the front panel of the MP 200 or the  button on the FM 200 remote control repeatedly if necessary until the desired source is shown in the display.

## Display



Folder



Folder



Folder

1/XX



Track



Track



Track

1/XX

## Playback of directories

In addition to the facility to play back individual folder content, it is also possible to play back entire directories. This is accomplished by selecting the folder of the directory to be played, then pressing the  button to start playback. Playback commences with the first entry in the list of content to be played. If an entry in the list should contain a folder with additional sub-folders, the content of the lowest folder is always played first. This is followed by the content of the next higher folder level, etc. (see diagram right).

**i** Only possible with UPnP and USB.

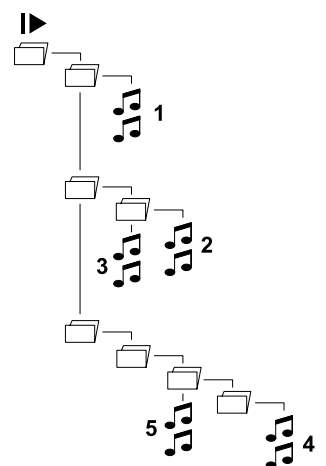

# CD player operation

## Source selection

---

Press the DISC button on the front panel of the MP 200 or the  button on the FM 200 remote control repeatedly if necessary until the source DISC is shown in the display.

## Insert and eject a disc

---

- Select Disc as source.
- Insert the disc into the drive with the label side facing up until the disc is automatically pulled in (see illustration).
- Briefly press the  button to eject the CD.
- As soon as the disc has been ejected, it can be removed.

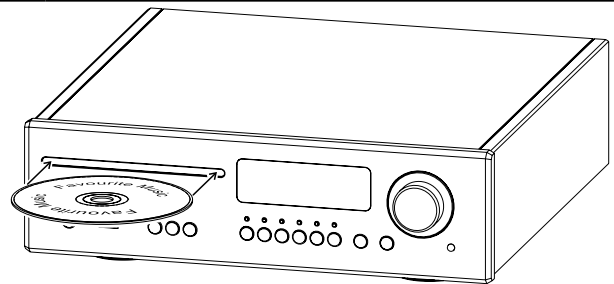

 The disc mechanism is designed to play round 12 cm standard discs only. Do not insert 8 cm discs or discs with unusual shapes. These may damage the drive.

## Playback mode

---

The CD player in the MP 200 features various playback modes. During playback the current playback mode is shown on the screen.

Big display view





Detailed display view



The playback mode can be set with the remote control only. Long presses on the  button on the FM 200 select the playback mode. Press repeatedly if necessary.

The following modes are available:

No indicator	Normal playback of the whole disc, or normal program playback.
	The tracks of the CD or a playback program are continuously repeated
	The track of the CD or a playback program which has just been played is continuously repeated.

# Playback Program

## Creating a Playback Program

A playback program consists of up to thirty tracks of a CD stored in any order you like. This can be useful, for example, when you are preparing a cassette recording. A playback program can only be created for the CD currently in the disc drawer of the MP 200. The program remains stored until it is erased again, or until the CD drawer is opened.

After loading the CD, the display shows the total number of tracks on the inserted CD, e.g.: 15 tracks 65:42'

Programming is only possible when the disc is stopped and only by remote control.



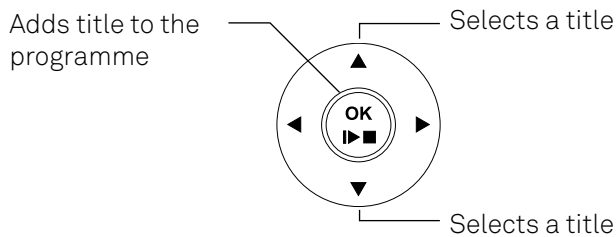

Activate playback programming by a brief press on the  button.

The display shows 'Add track 1' and '0 tracks / 0:00 programme duration'.



Use the ▲ ▼ buttons to select the desired title.

Press the  button to add the selected title to the playback programme.

The display shows the number of titles and the total playing time of the programme. Select all other titles in the same way and confirm by pressing the  button.

When all the titles have been selected for the playback programme, press and hold the  button to save the programme.

## Erasing a playback program

If you press the ▲ button on the MP 200, the CD is ejected and the playback programme is deleted. The programme can also be deleted by a long press on the  button.

# Bluetooth

## General information

The MP 200 integral Bluetooth interface provides a means of transferring music wirelessly from devices such as smart-phones, tablet PCs, etc. to the MP 200.

Socket for the Bluetooth antenna

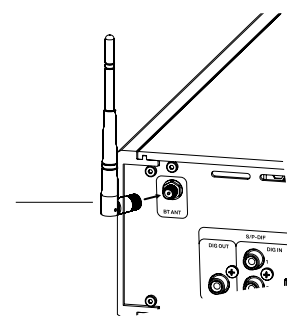

## Source selection

Press the BT button on the front panel of the MP 200 or the  button on the FM 200 remote control repeatedly if necessary until the source BLUETOOTH is shown in the display.

## Setting up audio transfer

Before music from a Bluetooth-capable device can be played through the MP 200, the external device must first be registered to the MP 200. As long as the MP 200 is switched on and no device is connected, it is always ready to receive. In this state the screen displays the message *not connected*.



To establish a connection, carry out the following steps:

- Start the search for Bluetooth devices on your mobile device.
- If the MP 200 is found, select it for pairing.

If the connection is successfully established, the device name of the connected device is shown at the bottom right of the display.

## Playback

Information on the piece of music currently being played is displayed on the screen of the MP 200 if this function is supported by the device connected to the unit.

The behaviour and method of operating the connected mobile device are determined by the device itself. Usually, playback can be controlled via the buttons on the remote control (start/stop, pause, skip).

 To control the MP 200 the mobile device must conform to the Bluetooth AVRCP protocol.

# Playback with Roon

## General information

---

The MP 200 supports playback via Roon.

Roon is a fee required software solution that manages and organizes your music stored on a server. Furthermore the streaming service TIDAL and Qobuz can be integrated.

## Playback

---

The operation is exclusively done via the Roon-App. The MP 200 is recognized as a playback device (client) and can be selected for playback in the app. As soon as Roon is used for playback, *ROON* appears on the MP 200 display as source.

Further information about Roon and its operation can be found at:  
<https://roonlabs.com>

# T+A Music Navigator App

## Download

---

Two Apps are available for controlling the sound system using the Apple iOS and Android operating systems. Please download the appropriate version from the Appstore and install it on your tablet PC or smartphone.

You will find the App under the name “*TA MUSIC NAVIGATOR*” in the Appstore. Alternatively you can scan the QR code printed below.

Android Version



Apple iOS Version





# Troubleshooting

Many problems have a simple cause and a correspondingly simple solution. The following section describes a few difficulties you may encounter, and the measures you need to take to cure them. If you find it impossible to solve a problem with the help of these notes please disconnect the unit from the mains and ask your authorised T+A specialist dealer for advice.

## Machine does not switch on

---

Cause:

Mains leads not plugged in correctly.

Remedy:

Check connection, push connector in firmly.

## Device responds correctly to operation via the buttons directly on the device, but cannot be operated by remote control

---

Cause:

The battery of the FM200 remote control is completely discharged.

Remedy:

Insert a new battery as described in the Remote control chapter.

## The RDS station name and/or the Radio Text does not appear in the display.

---

Cause 1:

Reception is poor, interference is severe, or the field strength (signal strength) is low.

Remedy:

Select only those stations which can be received with a strong signal: hiss-free and without interference.

---

Cause 2:

The display view is in the large format setting.

Remedy:

Switch to the detailed display view using the i key on the device. If necessary, tap several times to switch on the radio text.

## One or more sources cannot be selected via the source selection buttons on the device and the remote control

---

Cause :

The source in question has been disabled.

Remedy:

Enter the system settings menu and enable the disabled source.

## The CD in the disc drive can't be ejected properly

---

Cause :

The CD may not be readable properly (Wrong format or damaged)

Remedy:

Press and hold the eject button on the device for about 10 seconds until the CD is ejected.

## Transmission interruptions occur when listening to internet radio stations.

---

**Cause:**

The capacity of the internet radio station's server is at its limit.

**Remedy:**

Choose a different station.

## The streaming client cannot connect to a network.

---

**Cause 1 (cable LAN):**

Network cable not properly connected

**Remedy:**

Connect network cable, check connection to router

**Cause 2 (wireless LAN):**

WLAN antenna not connected or placed in a location with bad reception quality

**Remedy:**

Connect WLAN antenna properly and find a location with good reception quality.

Set the transmission power output of your WLAN router to maximum.

Try to establish a network connection first in a location close to the WLAN router. If this succeeded try to connect to WLAN from a more remote location. Experiment with antenna position and try to find a location with better reception quality.

**Cause 3 (wireless LAN):**

WLAN reception quality bad (low field strength). Possibly too much attenuated by walls/ceilings on the transmission path.

**Remedy:**

Optimize location of receiver and transmitter antennas.

**Alternative:**

If transmission problems persist a so called 'Power Line' network might be good alternative to establish a good and stable network connection.

The best, safest and most secure network however will always be a cable LAN network.

**Cause 4:**

Network parameters not properly configured.

**Remedy:**

Configure the network parameters correctly (see chapter 'Network configuration').

**Cause 5 (operation without network connection):**

For proper operation the MP 200 needs at least one properly connected network device. This can be a LAN or WLAN network or a USB storage device.

**Remedy:**

If the MP 200 shall be operated without network (LAN / WLAN) please connect at least a USB stick.

## USB Storage device is not recognised

---

**Cause 1:**

The storage device (especially USB hard discs without separate power supply) draws more electrical current from the USB interface than is permitted by the USB standard.

**Remedy:**

Only use USB storage devices that conform to the USB standard or use storage devices with own power supplies.

**Cause 2:**

The storage device is not formatted with an appropriate file system.

**Remedy:**

The MP 200 accepts storage devices with FAT16 or FAT32, NTFS, Ext2, Ext3, Ext4 file systems.

# Notes on energy saving

## General information

---

The MP 200 satisfies the requirements of the latest directives concerning energy-saving measures (EuP directive). The modern design of the mains power supply makes an important contribution to this. The internal micro-processor constantly ensures that sub-assemblies which are not currently required are automatically switched off. The micro-processor itself operates in stand-by mode at a relatively low clock speed, and only responds to the remote control receiver. In stand-by mode the current drain of the MP 200 is less than 0.5 Watt. If you intend not to use the device for a long period, it should be disconnected from the mains socket, i.e. the mains plug should be withdrawn from the wall socket.

## Automatic power down function

---

The device features an automatic power-down function. If the MP 200 detects no operation or no music signal for a period longer than 90 minutes, it automatically switches to stand-by mode

---

 *In countries outside the EU, in which the EuP directive has no validity, the automatic power-down feature can be disabled if necessary. See chapter „System settings“.*

# Legal Information

## Allgemeine Informationen

---

This product contains software in form of object code that is partially based on free software under different licenses. Details of the licenses used can be viewed on the device website using an Internet browser.

## Show licenses

---

To access the devices web page, enter the IP address of the device and „/licensens/“ in the address bar of the browser you are using.

For example <http://192.168.178.100/licenses/>

You can view the exact address as follows:

- Call up the system configuration menu by pressing the SYS button on the MP 200.
- Then navigate to the Device Info menu item.
- Open it by pressing the SELECT knob and then navigate to the Legal Information menu item and open it by pressing the SELECT knob again.
- The address of your device is displayed in the pop-up window that now opens.

---

 *The address is only displayed in the pop-up window if the device has a correctly configured network connection. For details on network configuration, see the „Network Configuration“ section.*

*To view the devices website, the device on which the internet browser is launched must be connected to the same network as the device.*



# Firmware update

## General information

---

For updating the firmware of the MP 200 there is a convenient method which requires an existing Internet connection

If you are operating the MP 200 in conjunction with a DAC 200 or HA 200, the machine can also be updated via the SYS-Link connection.

The wiring diagram for the machine is shown in the chapter [Connection and wiring](#).

The following section describes the exact method of updating the firmware in detail.

---

**i** *To avoid malfunctions after updating the MP 200, all devices in the system should always be checked for any available updates and installed if they are available.*

## Update procedure

---

- The basic requirement is a functioning network with router and access to a broadband Internet connection; the system must be operating.
- Switch the machine on.
- Call up the System menu by pressing the SYS-button on the front panel.
- Rotate the SELECT knob on the front panel to select the *Device info* menu point, and confirm your selection by pressing the SELECT knob.
- If the MP 200 is connected to a DAC 200 or a HA 200 via the SYS-Link connection, the device selection menu appears at this point. In this case select the device to be updated by turning the SELECT knob, then press the SELECT knob to confirm your choice.
- (If the MP 200 is not connected to a DAC 200 or a HA 200, the Software Update menu of the MP 200 appears directly.)
- Select the *Update* menu point by rotating the SELECT knob, then press the SELECT knob to confirm your choice.
- The select option *WEB* should now be active (highlighted).
- The firmware update can now be started by pressing the SELECT knob.
- The screen displays the current state of progress of the update.
- Once the update has been completed (duration 10 - 40 minutes) the device automatically switches itself off and restarts.
- When the machine has restarted, the update is complete.
- To ensure that the update was successful, access the *Device Info* menu point mentioned above, and check the new firmware status.

**i** *Instead of starting the update process directly on the device, it is also possible to operate the update process via the FM200 remote control.*

# Connection and wiring

MP 200 in combination with DAC 200 or HA 200

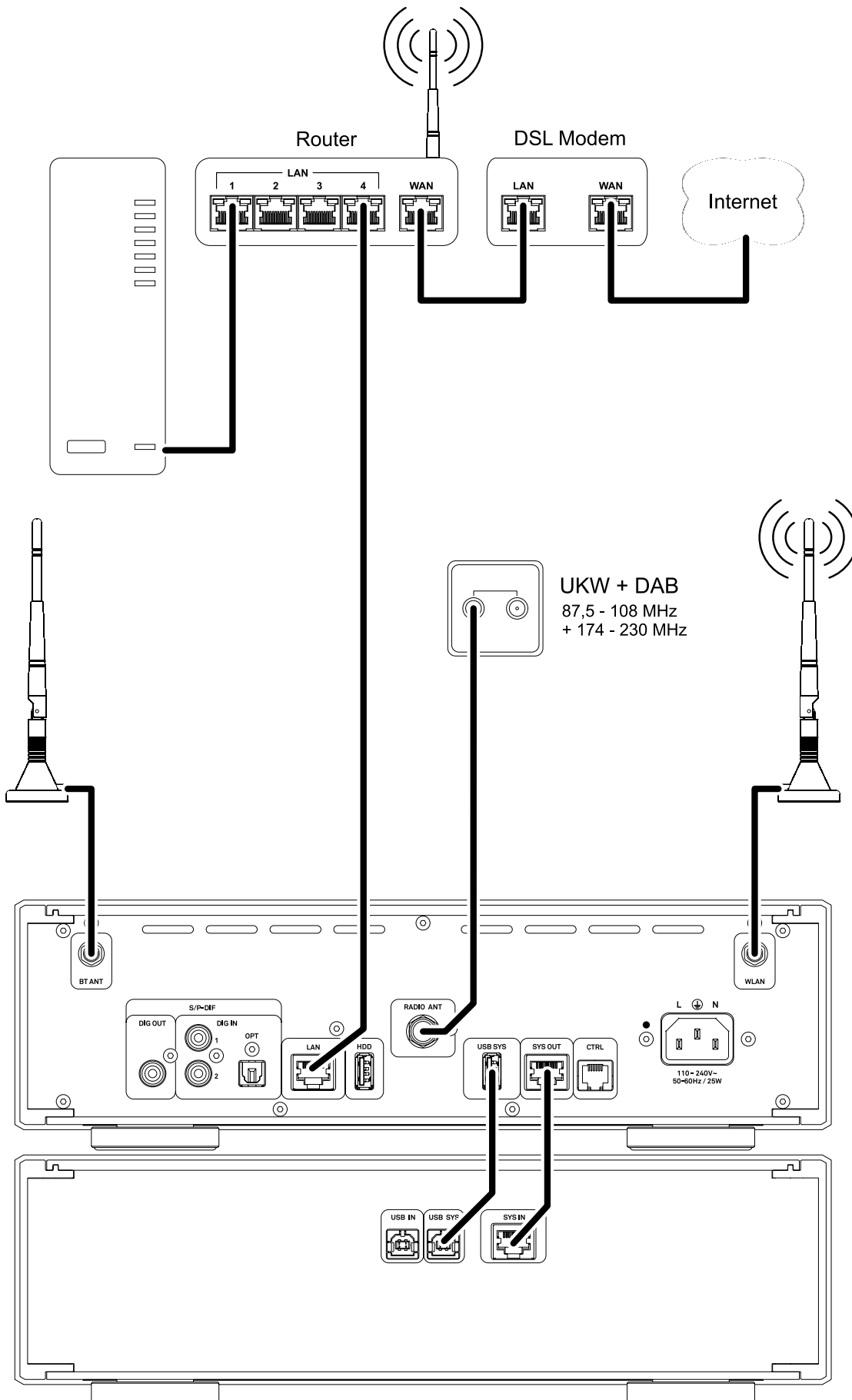

MP 200 in combination with another DAC or amplifier with digital input

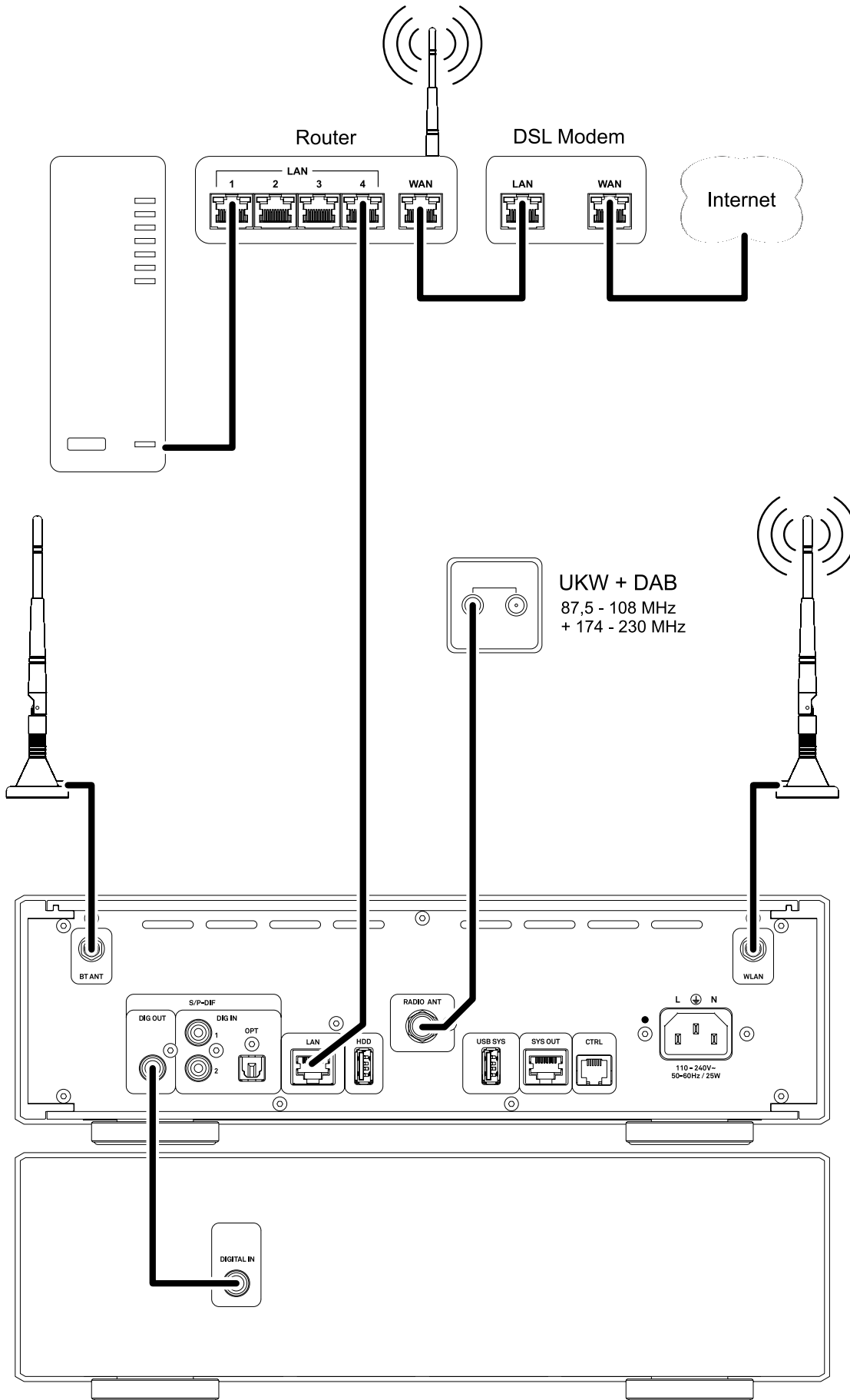

# Technical Specifications

---

## CD-Player

Formats	CD/DA, CD-R, CD-RW, CD-text
Frequency response and dynamic range	2 Hz – 20 kHz / 100 dB

---

## Streaming Client

Formats	MP3, AAC, OGG-Vorbis, FLAC, WAV, AIFF, ALAC PCM 32 ... 192 kHz, 16/24 Bit; MP3 bis 320 kBit
Supported media servers	UPnP 1.1, UPnP AV and DLNA kompatible Server, Microsoft Windows Media Connect Server (WMDRM10, DLNA compatible servers)
Features	Auto Network Config., Internet Radio Station database (automatic updates)
Interfaces	LAN: Fast Ethernet 10/100 Base-T, WLAN: 2,4 GHz, +20 dBm (100 mW), IEEE 802.11 b/g/n 2x USB 2.0 Mastermode

---

## Tuner (FM)

Frequency range	FM Radio 87,5 – 108 MHz (Europa / US); 76 – 90 MHz (Japanese version))
Sensitivity	Mono (26dB S/N) 0,9 µV, Stereo (46 dB S/N) 40 µV
Overload margin	103 dB µV,
Stereo channel separation	50dB
RDS Functions	Stationname, Radio text

---

## Tuner (DAB)

Reception standard	DAB, DAB+
Frequency band	168 – 240 MHz (Band III)
Overload margin	103 dB µV,
Sensitivity (BER = 10 – 4)	2,5 µV

---

## Bluetooth

Supported audio formats	APT-X, MP3, AAC, SBC
Frequency band	2,4 GHz: 2042Mhz ... 2480Mhz Max. transmission power <10 dBm (EIRP)
RC protocol	AVRCP



---

**Inputs**

---

SP/DIF (16-24bit): 2x coax (192kHz), 1x TOS-Link (96kHz)

---

---

**Outputs**

---

Digital output coax (IEC 60958), SYS-LINK USB output

---

---

**Mains in**

---

115 – 240V, 50 – 60 Hz, 25 Watts

---

---

**Normal operation (max.)**

---

25 W

---

---

**Standby (ECO)**

---

< 0,5 W

---

---

**Automatic power down**

---

After 90 Minutues without music signal

---

---

**Dimensions (WxHxD)**

---

10 × 32 × 34 cm

---

---

**Accessories**

---

Remote control handset FM200, Mains cord, USB-SYS-cable and RJ-45 SYS-Link-cable for connection of a DAC 200 or HA 200, WLAN and Bluetooth antenna, FM antenna

---

---

**Weight**

---

4,4 kg

---







T+A elektroakustik GmbH & Co. KG  
Planckstraße 9 – 11  
32052 Herford | Germany

T +49 5221 76760  
F +49 5221 767676

[info@ta-hifi.com](mailto:info@ta-hifi.com)  
[www.ta-hifi.com](http://www.ta-hifi.com)